

# ERL放射光源計画の進捗状況

河田洋<sup>1</sup>、小林幸則<sup>1</sup>、春日俊夫<sup>1</sup>、佐藤康太郎<sup>1</sup>、  
羽島良一<sup>2</sup>、中村典雄<sup>3</sup>、坂中章悟<sup>1</sup>

<sup>1</sup> 高エネルギー加速器研究機構 (KEK)

<sup>2</sup> 日本原子力研究開発機構 (JAEA)

<sup>3</sup> 東京大学物性研究所 (ISSP)

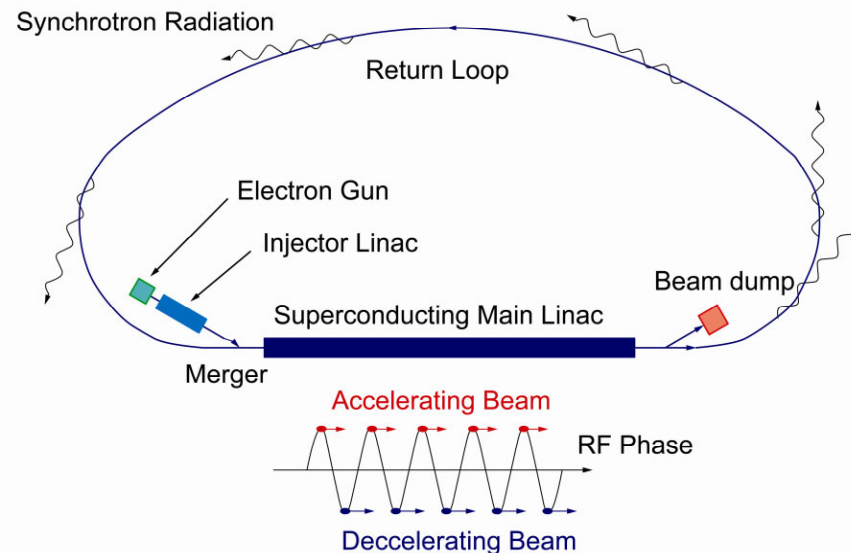

# ERL関係発表

- 5-GeV ERLにおける共振器型X線自由電子レーザーの設計  
羽島良一(他) 9P009
- ERL放射光源のための低エミッタンス大電流電子銃の開発  
羽島良一(他) 9P010
- ERL電子銃励起用EO変調器型Ybファイバーレーザー発振機  
の開発  
伊藤功(他) 9P011
- ERL主ライナック入力カプラー開発  
阪井寛志(他) 9P012
- cERLのラティス設計  
島田美帆(他) 9P013
- ERL主加速器のためのモジュール開発の現状  
梅森健成(他) 9P014

# Comparison of ERL, SASE-FEL and XFEL-O

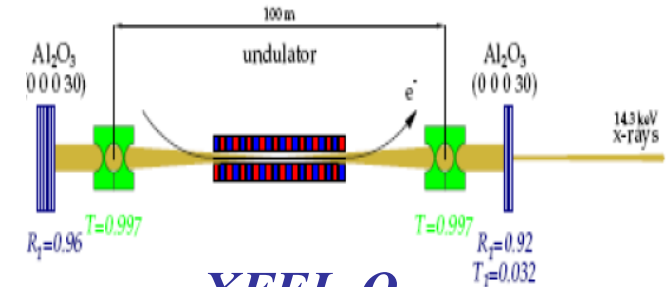
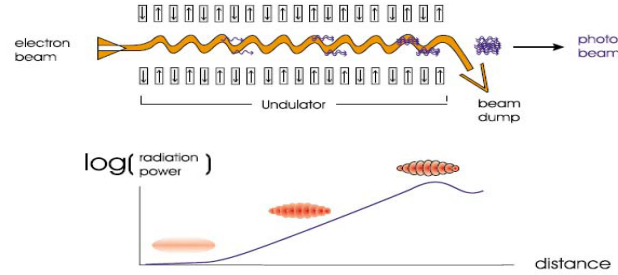
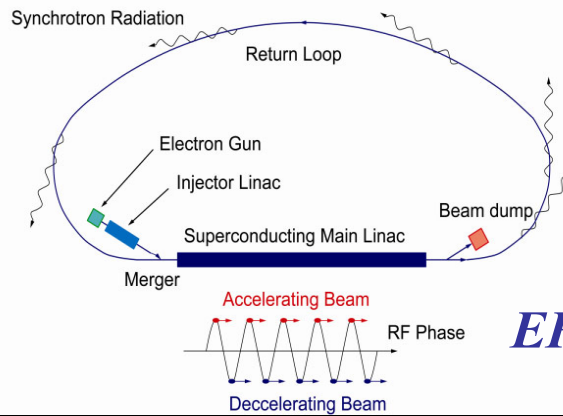

K.-J. Kim, Y. Shvyd'ko, S. Reiche, PRL. **100**, 244802 (2008).

	average brilliance	peak brilliance	repetition rate (Hz)	coherent fraction	bunch width(ps)	# of BLs	Remark
ERL	$\sim 10^{23}$	$\sim 10^{26}$	1.3G	$\sim 20\%$	0.1~1	$\sim 30$	Non-perturbed measurement
XFEL-O (Option)	$\sim 10^{27}$	$\sim 10^{33}$	$\sim 1M$	100%	1	few	Single mode FEL
SASE-FEL	$\sim 10^{22\sim 24}$	$\sim 10^{33}$	100~10K	100%	0.1	$\sim 1$	One-shot measurement
3 <sup>rd</sup> -SR	$\sim 10^{20\sim 21}$	$\sim 10^{22}$	$\sim 500M$	0.1%	10~100	$\sim 30$	Non-perturbed measurement

(brilliance : photons/mm<sup>2</sup>/mrad<sup>2</sup>/0.1%/s @ 10 keV)

# Merger of Accelerator Laboratory and PF Light Source Division (Before 1<sup>st</sup> of April / 2009)

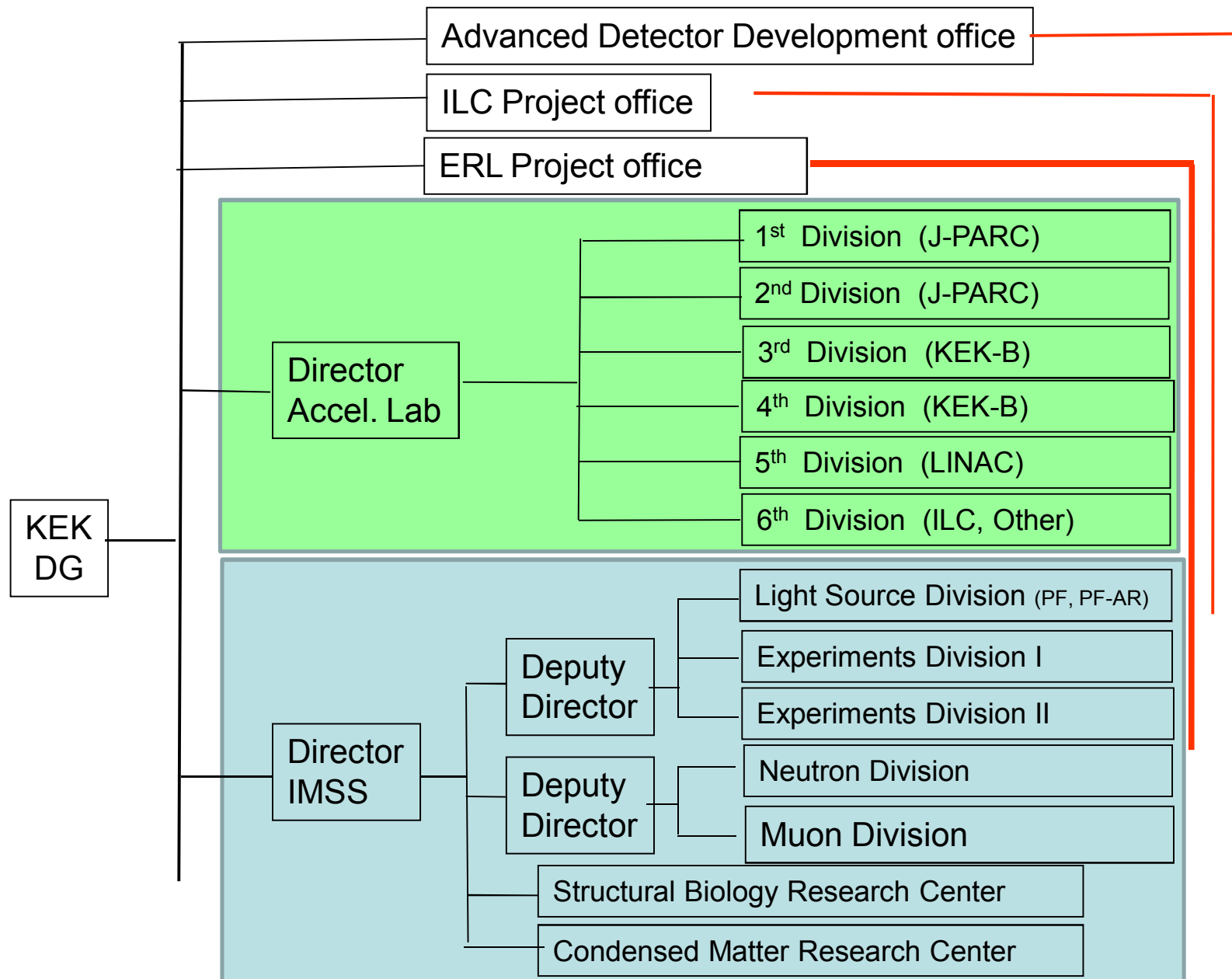

# Merger of Accelerator Laboratory and PF Light Source Division (After 1<sup>st</sup> of April / 2009)

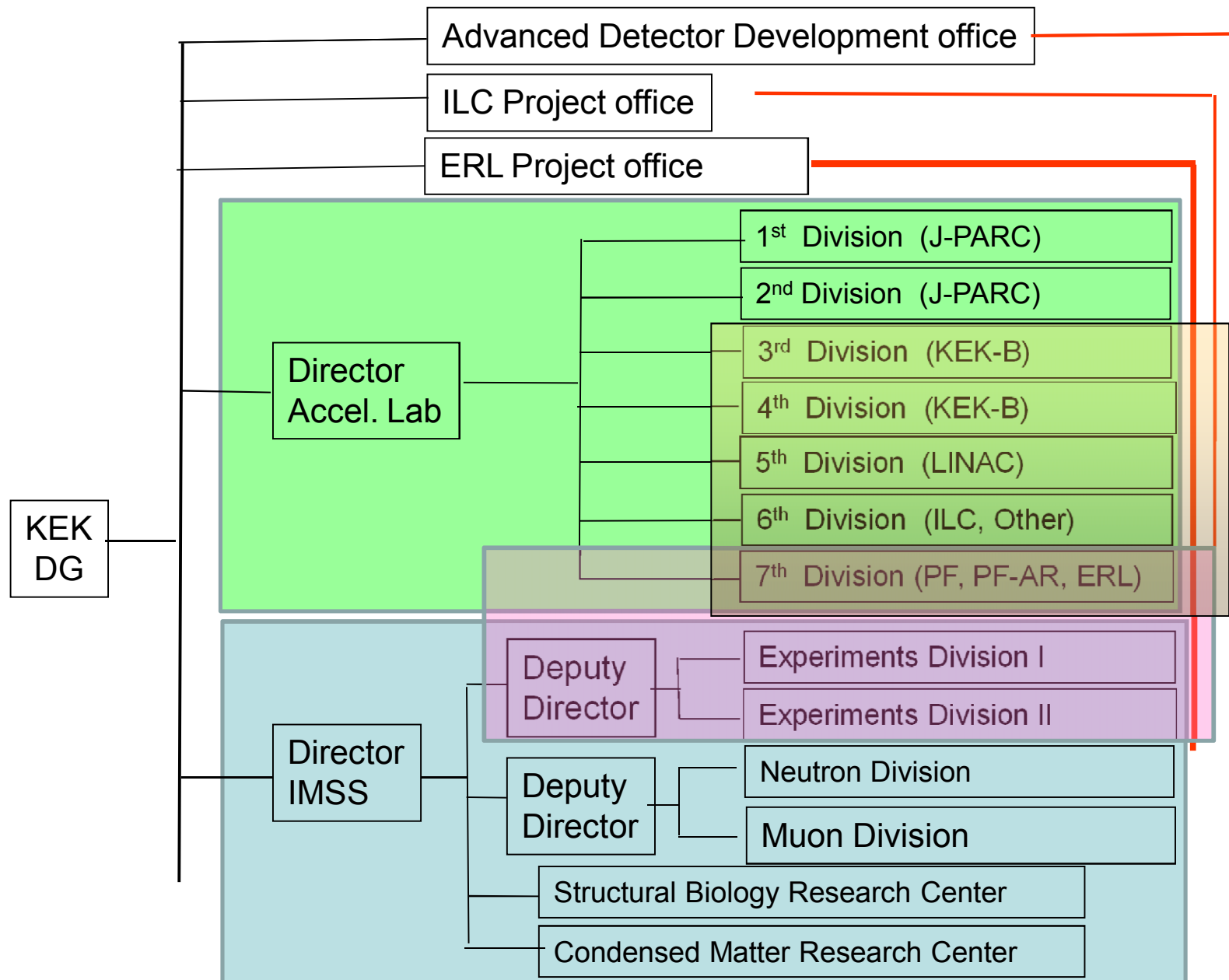

# Development of ERL until 2008

**CDR of Compact ERL  
has been published**

**Super conducting cavity for main accelerator**  
Single cell model  $\Rightarrow$  9 cell model  $\Rightarrow$  Ready for the fabrication  
of the cavity for Compact ERL

**super conducting cavity of pre-accelerator**  
2 cell model  $\Rightarrow$  Ready for the fabrication of the cavity  
for Compact ERL

***Construction phase from 2009!***

**Injector**  
Started the designing.

**high power RF source**  
300 kW Klystron will be  
ready by October 2009

**500kV·DC electron gun**  
The fabrication has started  
under the collaboration with  
JAEA, ISSP, Hiroshima Univ.,  
Nagoya Univ. and KEK.

**Laser system for electron gun**  
Development of Yb fiber-laser system in  
collaboration with AIST, ISSP and KEK.  
 $\Rightarrow$  Ready for the system of 10 mA  
electron beam current.

**Lattice, Magnet,  
Vacuum**  
Designing stage

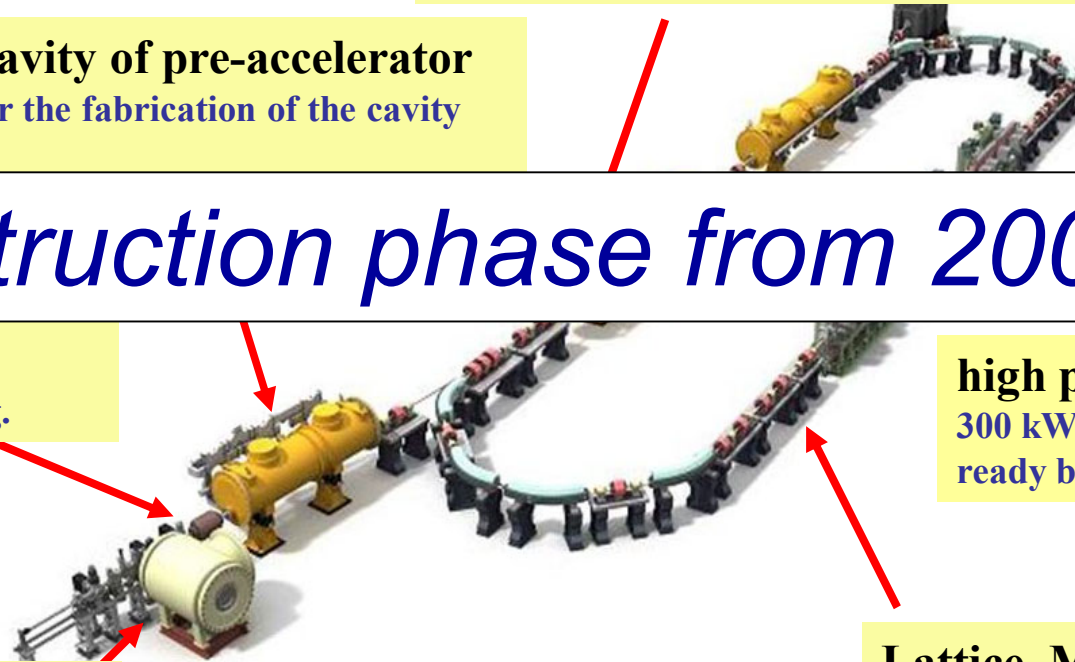

# Compact ERL in East Counter Hall





# Reconstruction of East Counter Hall



Feb.2009



02/Dec.2009





# Development of DC Photocathode Gun

Collaboration with JAEA, Hiroshima Univ. and Nagoya Univ.

## Goals:

- High voltage: 500 kV
- High average current: 10 - 100 mA
- Low emittance: 0.1 - 1 mm·mrad
- Long cathode lifetime (> hours)
- GaAs NEA cathode

## Photocathode preparation chamber

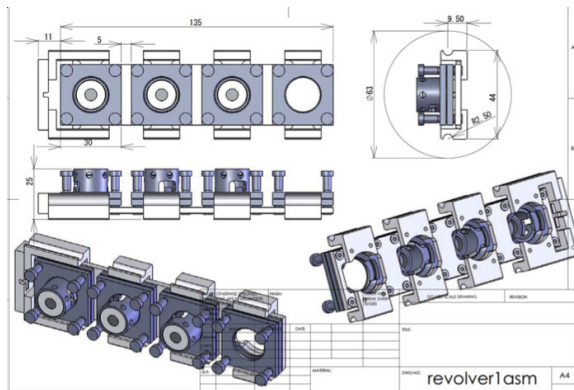
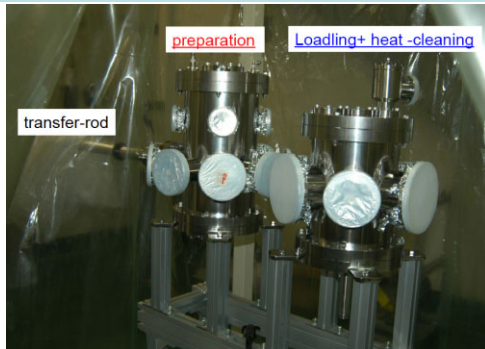

## HV insulation tank

Designed and under construction.

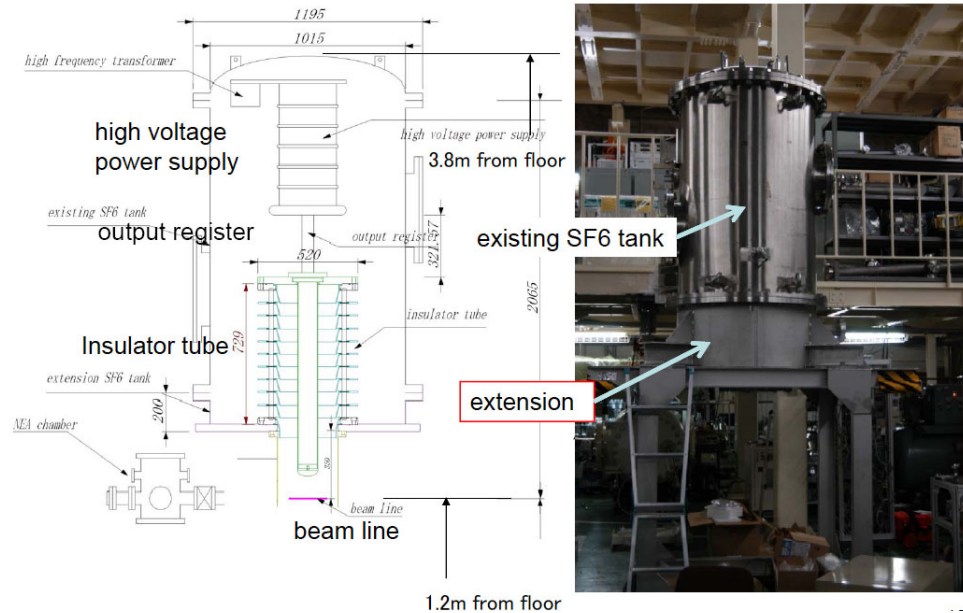

## Segmented ceramic insulator

- Guarding ceramic insulator from impinging field-emitted electrons
- Expect to prevent damage due to field emissions

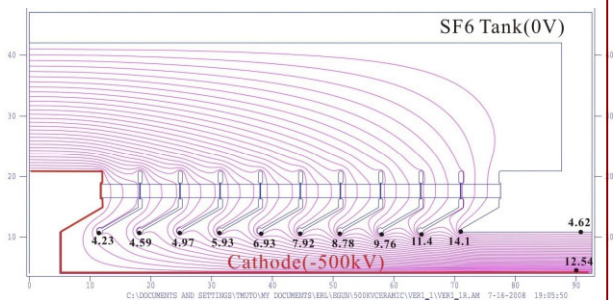

# Development of Superconducting Cavities

## Injector Cavities

- 2-cell cavity design
- Medium gradient: 15 MV/m
- High input power: 85-170 kW/coupler
- Improved HOM coupler design

## Status

- First prototype cavity was fabricated and tested.
- Achieved field gradient of 30 MV/m for a short time.



Prototype cavity.

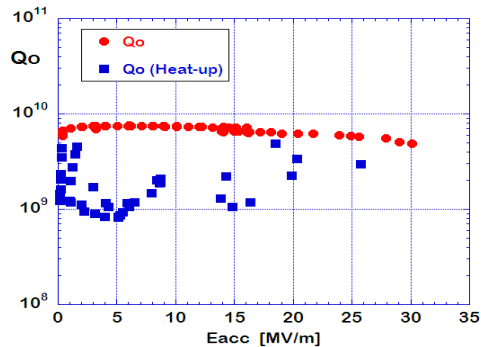

Result of the first vertical test.

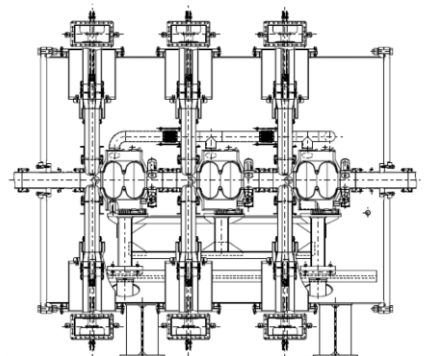

## Main-Linac Cavities

- 9-cell cavity design
- HOM damping with large beam pipes/absorbers
- High beam current: 200 mA
- CW operation with 15 - 20 MV/m

## Status

- First prototype cavity was fabricated and tested.
- Achieved field gradient of 15 MV/m.

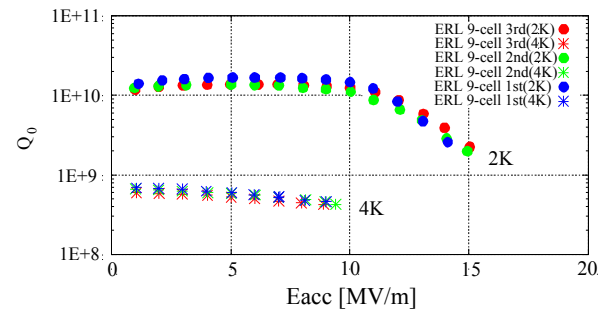

Result of the first vertical test.



Prototype cavity.

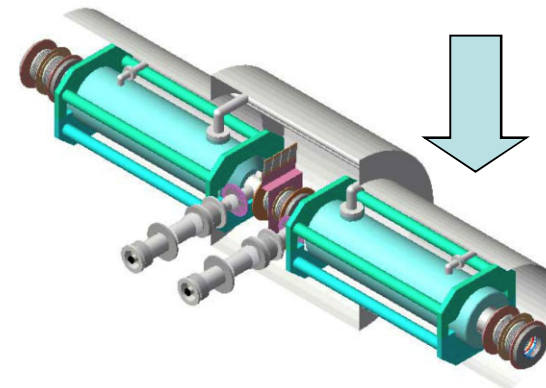



# Development on RF source

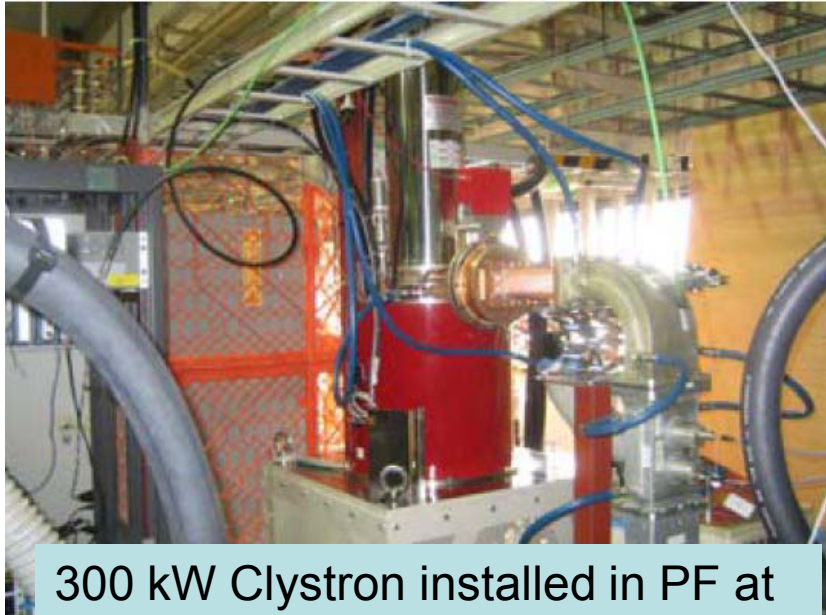

300 kW Clystron installed in PF at the middle of Oct. 2009.

Prof. Fukuda and his coworkers;  
commissioning members of the Clystron.

The commissioning has been finished at the beginning of Dec. of 2009 and the test for an input coupler will start from the middle of Jan. of 2010.





# ERL09 (Energy Recovery Linac 45th ICFA Beam Dynamics Workshop June 8-12, 2009, Ithaca, USA)



- KEK and JAEA will organize the next workshop of ERL2011

<http://www.lepp.cornell.edu/Events/ERL09/>

# ERL Science Workshop

<http://pfwww.kek.jp/pf-seminar/ERL/workshop/index.html>

## ERL Science Workshop (domestic workshop)

Date : 9-11 July 2009

Site: KEK

- #) Outline of ERL project
- #) **Femto-second science**
- #) **Local structures in disordered materials**
- #) **Hierarchical structure in materials at a space and a time domains**
- #) **Sophisticated Instrumentation**
- #) **Discussion**



Numbers of participants: 85

**KEK Proceedings 2009-4**

<http://ccdb4fs.kek.jp/tiff/2009/0925/0925004.pdf>



# Femto-second science

“Time-resolved techniques with next generation femtosecond pulsed synchrotron radiation sources” By Y. Tanaka, RIKEN

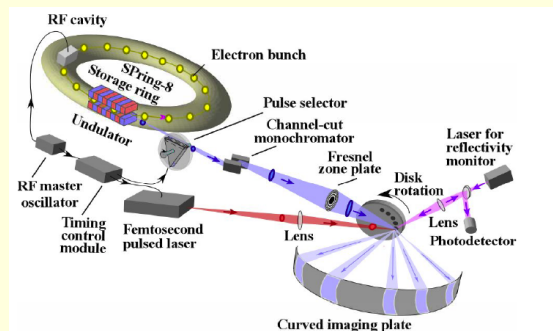

Tanaka et al., Jpn. J. Appl. Phys., 48, 03A001 (2009).

- ERL promises the dynamics measurements with the wide time range (m-sec to femto-sec).
- Development of femto-sec timing technologies.

“Ultrafast structural tracking of reacting molecules and expectation for synchrotron radiation of the next generation” By T. Tahara, RIKEN

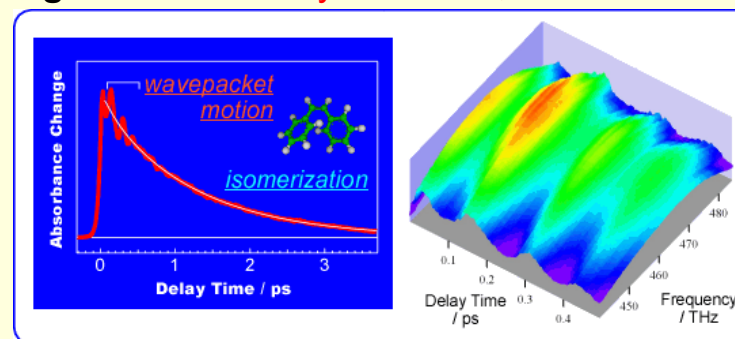

- Direct observation of the structural change (fluctuation) in bio-molecules (X-FELO)

“Time resolved XAFS research of materials chemistry” By Y. Inada, Ritsumeikan Univ.

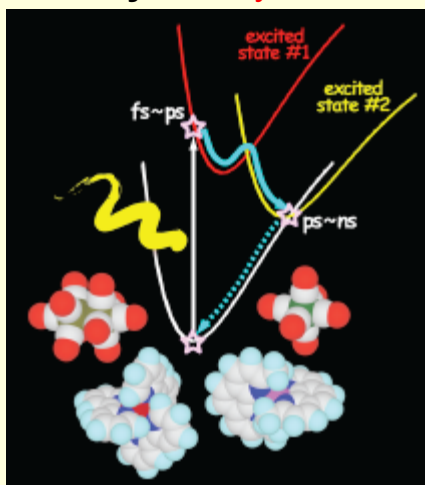

- To understand the chemical function of catalysis, dynamics measurements with the wide time range (msec to femto-sec) is essentially important.

“Ultrafast spectroscopy of photo-induced phase transition in organic salts” By S. Iwai, Tohoku Univ.

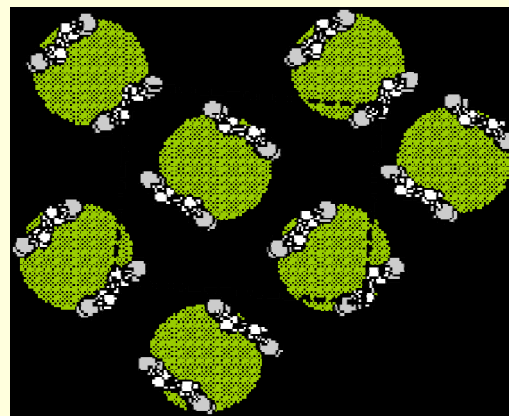

- Dynamics of domain (cluster) formation and domain boundaries

# Local structures in disordered materials

“Advanced single molecule observations and the task of the next X-ray light sources” By Y. C. Sasaki, The Univ. of Tokyo

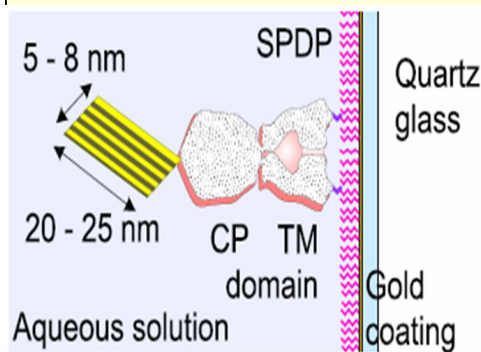

- Structural determination from single molecules
- High speed (ps-fs) and high accuracy (pm)
- Single molecule calorimeter
- Control of functional dynamical behaviors

“Electronic function at the non-equilibrium solid/liquid interfaces” By Y. Iwasa, Tohoku Univ.

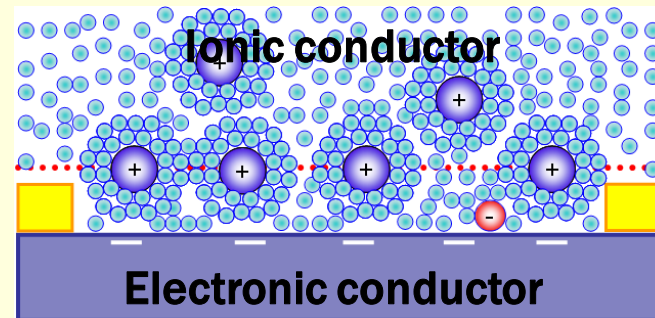

- Challenge: Discover new superconductors
- Multidisciplinary materials science in non-equilibrium states at solid-liquid interfaces

“Present status and perspective of materials research on spintronics” By K. Takanashi, Tohoku Univ.

- Challenge of the observation of spin current at the interface with the spatial resolution of atomic level.

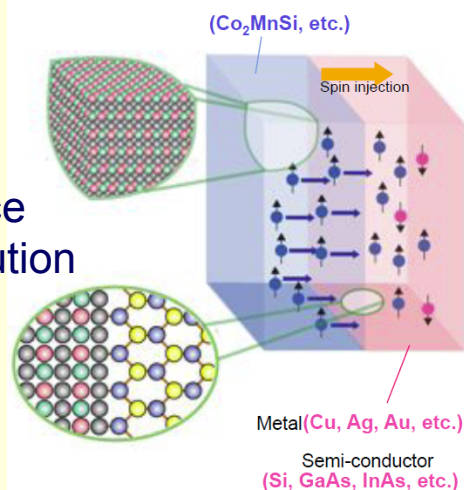

“Study on chemical reaction at surfaces/interfaces and future prospects” By H. Kondoh, Keio Univ.

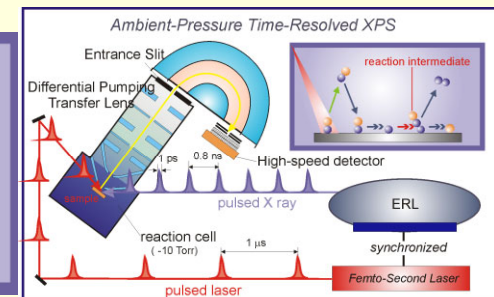
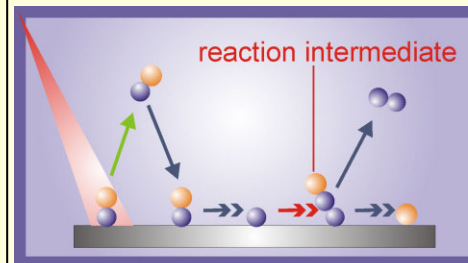

- Chemical reaction at the surface/interfaces
- To clarify the intermediate states with nm spatial resolution

# Hierarchical structure in materials at a space and a time domains

“Slow electronic fluctuation in electronic ferroelectric  $\text{LuFe}_2\text{O}_4$ ” By N. Ikeda, Okayama Univ.

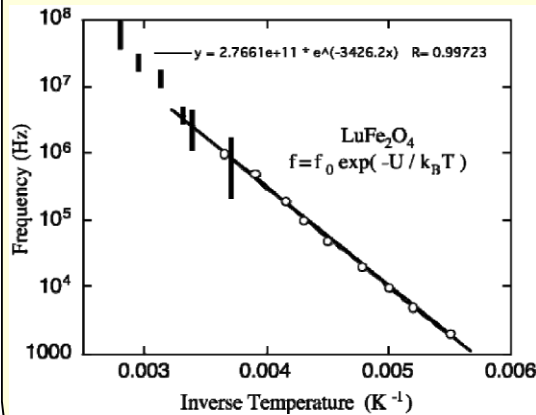

- Frustration system of the charge and orbital ordering of  $\text{Fe}^{2+}$  and  $\text{Fe}^{3+}$ .
- Investigate the domain formation to clarify the magneto-dielectric response!

“Current situation and future prospects of an application of x-ray photo correlation spectroscopy to the solid state physics” By K. Ohwada, JAEA

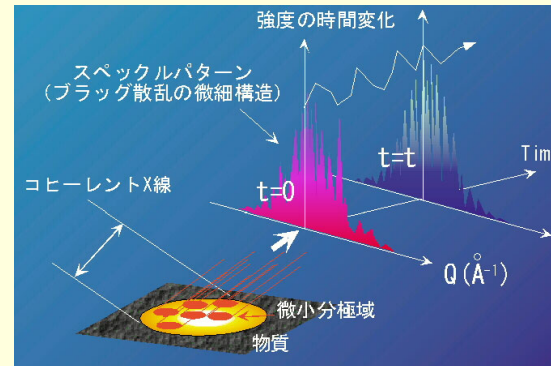

- We need 2-3 order higher coherent flux to investigate the super-lattice diffractions

“Imaging of hierarchical structures of the cell using coherent X-ray” By M. Nakasako, Keio Univ.

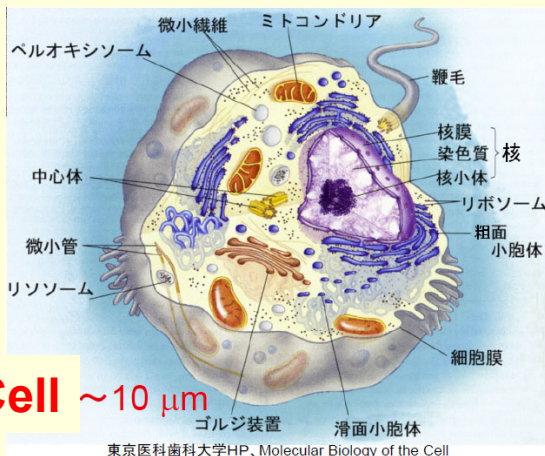

- Investigate the bio-molecules in a cell to clarify the function

“Hierarchical structure of soft matter and expectations for ERL” By Y. Shinohara, the UNiv. of Tokyo

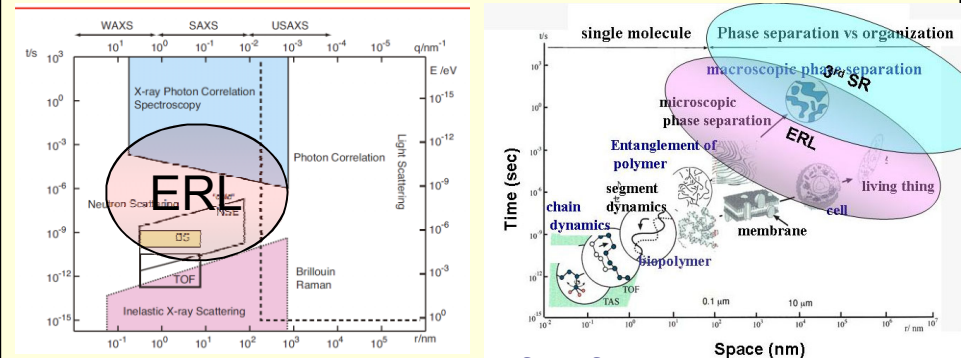

Hierarchical structure of soft materials (Non-crystalline, disordered material, and fluctuation)



# Sophisticated Instrumentation

“Present status and perspective of diamonds as x-ray optical element” By K. Tamasaku, RIKEN

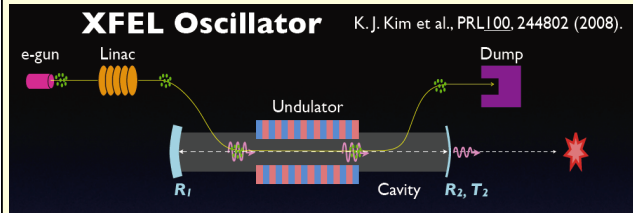

• Still there are many things to improve the performance (Imaging applications, thinning and polishing diamond crystal plates)

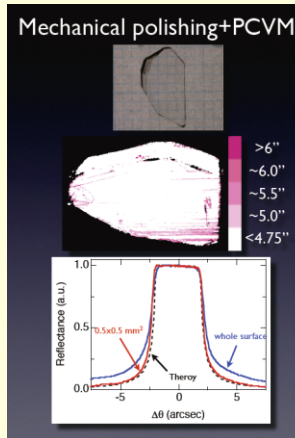

“Development of next generation high-speed 2D X-ray detector with SOI technology” By Y. Arai, KEK

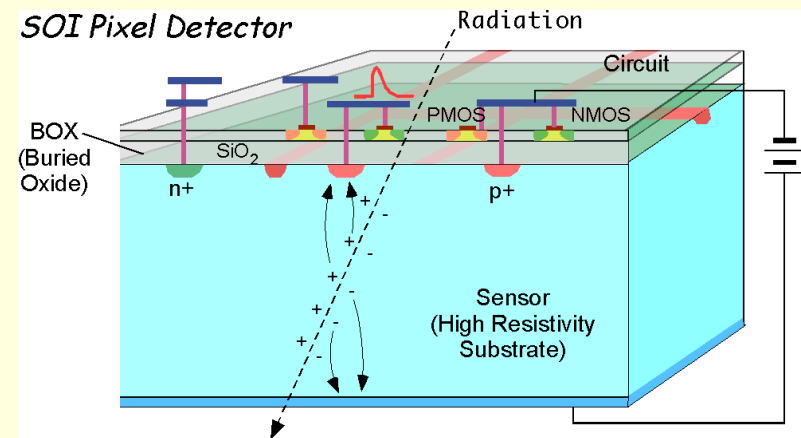

“Light source performance of X-FELO” By R. Haiima, JAEA

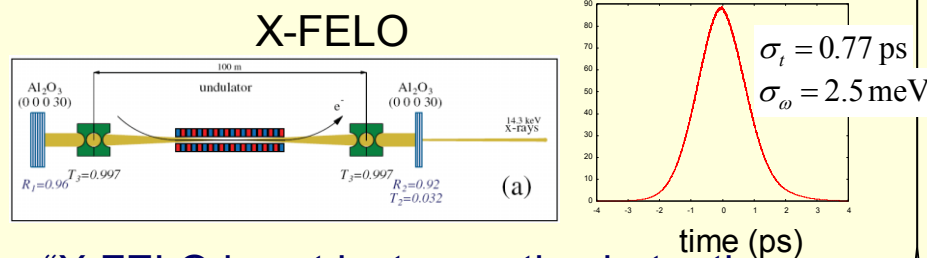
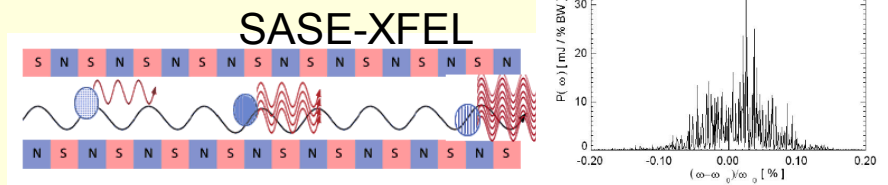

“X-FELO is not just an option but rather one of the targets of the KEK-ERL project!”

“Development of hard x-ray optical systems/devices” By A. Takeuchi, JASRI/Spring-8  
 Focused beam of 1 nm will be possible by using several techniques.

It is necessary to recognize the following issues.

1. Vibration: optics, light source, ground, and building
2. Temperature stability
3. Radiation damage of the optical components
4. Measurement systems for nm order
5. Speckles from optics

# Summary of the ERL scientific workshop 1

- Femto-second science
  - ERL promises the dynamics measurements with the wide time range (msec~fsec) based on pump-probe experiment.
  - X-FELO would be a wonderful light source (1MHz,  $10^9$  photons/pulse with the energy resolution of several meV).
- Local structures in disordered materials
  - 10 nm spatial resolution gives us functional information in disordered materials and surface/interface, electric double layers, and spintronics.
  - A number of experimental techniques to be developed such as fast-detectors, combination with other imaging techniques, triggering system for chemical reactions, and so on.
- Hierarchical structure in materials in a wide range of spatial and time domains
  - High brilliance coherent X-rays with high repetition rate (1.3 GHz) will give us a new scientific activities on hierarchical structure in materials at a space and a time domains. (form slow dynamics to  $10^8$ Hz and sub nm to mm)
  - Development of detectors for XPCS is essentially needed.



# Summary of the ERL scientific workshop 2

- Sophisticated Instrumentation
  - “X-FELO is not just a option but rather one of the targets of the KEK-ERL!”
  - There are a number of things to develop optics, detectors, and facilities.
- Future workshops
  - Separate workshops corresponding to each scientific sessions featured in July workshop will be organized by the leadership of the ERL project office.
  - Scientific sessions on the applications of X-FELO should be included.

## **21<sup>st</sup>/ Dec./ 2009      Seminar for XFEL-O (KEK)**

“Welcome & Opening address”

**Osamu Shimomura (IMSS/ KEK)**

“An X-ray Free Electron Laser Oscillator: Promises and Challenges”

**Kwang-Je Kim (APS/ ANL)**

“A simulation work of a velocity-bunching XFEL-O “

**Nobuyuki Nishimori (JAEA)**

“The idea how to measure dynamical charge susceptibility combined with X-ray and Neutron inelastic scattering”

**Jun-ichiro Mizuki (JAEA)**



# Preliminary Design of 5GeV ERL

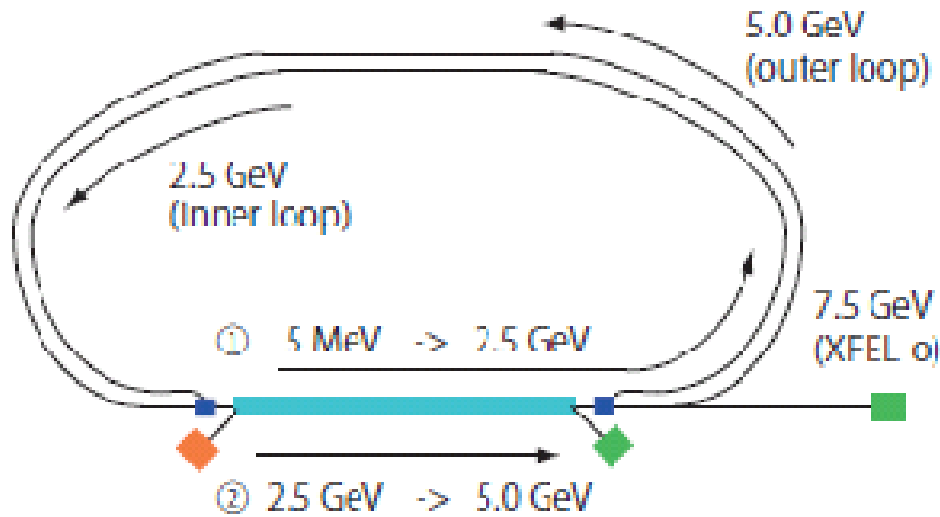

Energy Recovery Mode

- ③ 5.0 GeV  $\rightarrow$  2.5 GeV
- ④ 2.5 GeV  $\rightarrow$  5 MeV

XFEL-o Mode

- ③ 5.0 GeV  $\rightarrow$  7.5 GeV

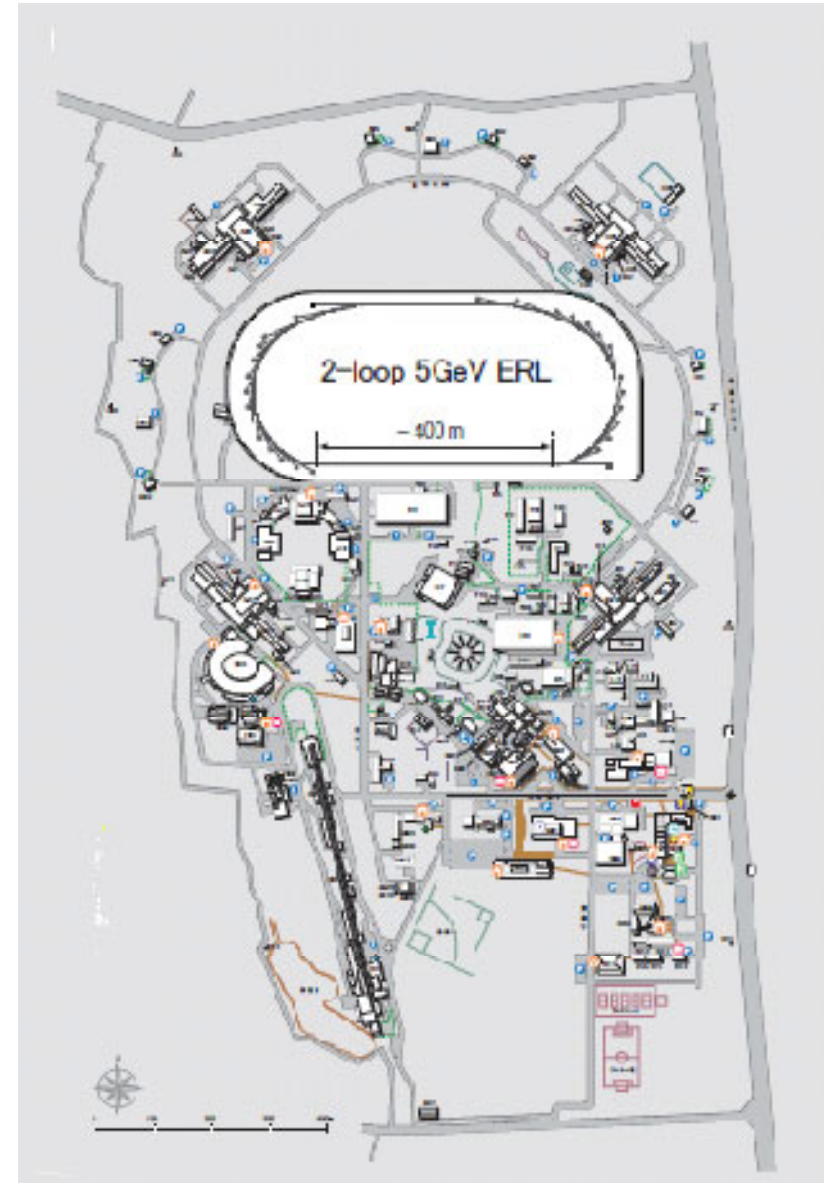
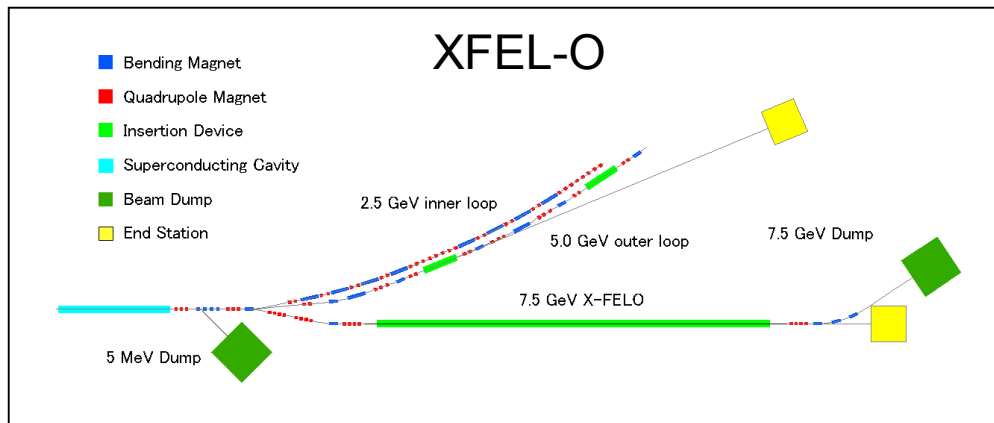

# cERL, KEK-X, ERL: target timelines

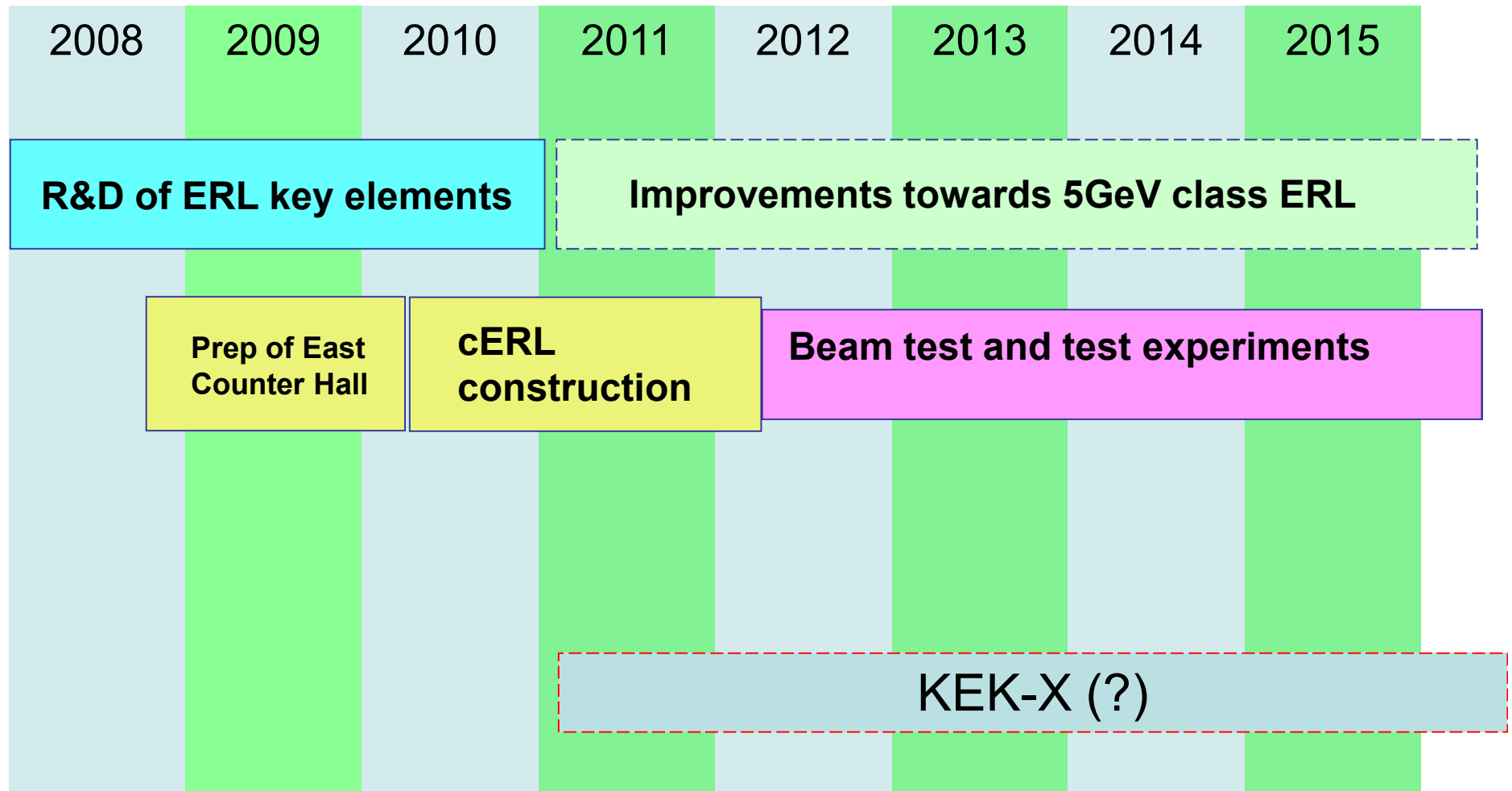

References:  
KEK roadmap, March 2008  
Design of compact ERL, Hajima et al., pp. 160-161.

\* to be updated periodically

# Summary

- We have started the construction of c-ERL in FY2009.
- The EAST counter hall will be ready to construct the accelerator components at the April of 2010
- ERL Science workshop has been organized successfully. Users are very much interested in the possibility of ERL and also XFEL-O.