

# ERL15

## 簡単な発表の様子の紹介＋ WG4(RF/SRF)のまとめ ＋BNL見学(一部)

2015/6/15

H.Sakai

ERL15の発表資料は全部

<https://indico.bnl.gov/conferenceDisplay.py?confId=909&view=standard>

にあります。

46pages

# ERL15 の内容



ERL'15 Synoptic Table

Sunday - June 7	Monday - June 8	Tuesday - June 9	Wednesday - June 10	Thursday - June 11	Friday - June 12	
	Registration / Theater lobby	Theater	Lecture Hall 1 Science Center: ERL as a Synchrotron Light Source	Lecture Hall 2 Non-destructive Beam Position Monitoring in Two-Beam Section of ERL	Lecture Hall 1 Satellite Meeting	Lecture Hall 2 Diagnostic TestBeam-Line for The MESA Injector
8:30	Theater	WG1 Challenges in Guns and Injectors	H. Kawata (KEK)	T. Ohma (KEK)		I. Alexander (Institute for Nuclear Physics - Mainz U.)
9:00	Opening S. Belomezenko (BNL/SBU)	WG2 Beam Dynamics Challenges in ERLs		Beam Current Monitoring with SCT and BPM Electronics		A Fast Rotating Wire Scanner for Use in High Intensity Accelerators
9:10	Welcome I. Ben-Zvi (BNL)	M. Abolzar (HZB) & V. Posen (BNL)	ERL as FEL Driver	F. Prayve (BNL)		S. Full (Cornell U.)
9:15	Energy Recovery Linacs: Past, Present and Future M. Tigner (Cornell University)	WG3 ERL Instrumentation and Control	Y. Jing (BNL)	Fast Electron Beam and FEL Diagnostics at the ALICE IR-FEL at Daresbury Laboratory		Detection and Clearing of Trapped Ions in the High Current Cornell Photoinjector
9:20		T. Ohma (KEK) & C. Quilford (Cornell University)	ERL Facility at CERN for Applications	F. Jackson (STFC Daresbury)		S. Full (Cornell U.)
9:25		WG4 SRF Challenges in ERLs	E. Jansen (CERN)	Current Measurement and Associated Machine Protection in the ERL at BNL		GAAs Photoacode R&D
9:30	ERL-based Electron-Ion Colliders V. Pagan (BNL/SBU)	H. Sakai (KEK) & E. Jansen (CERN)		T. Miller (BNL)		L. Jones (STFC/Cockcroft)
9:35		WG5 Applications	An Lepton Energy-recovery-linac Scalable to TeV	Discussion		
9:40		V. Litvinenko (BNL/SBU) & D. Bruening (CERN)				
9:45		Discussion				
9:50						
9:55						
10:00	Group photo / Theatre lobby					
10:05						
10:10						
10:15						
10:20						
10:25						
10:30						
10:35						
10:40						
10:45						
10:50						
10:55						
11:00						
11:05						
11:10						
11:15						
11:20						
11:25						
11:30						
11:35						
11:40						
11:45						
11:50						
11:55						
12:00						
12:05						
12:10						
12:15						
12:20						
12:25						
12:30						
12:35						
12:40						
12:45						
12:50						
12:55						
13:00						
13:05						
13:10						
13:15						
13:20						
13:25						
13:30						
13:35						
13:40						
13:45						
13:50						
13:55						
14:00						
14:05						
14:10						
14:15						
14:20						
14:25						
14:30						
14:35						
14:40						
14:45						
14:50						
14:55						
15:00						
15:05						
15:10						
15:15						
15:20						
15:25						
15:30						
15:35						
15:40						
15:45						
15:50						
15:55						
16:00						
16:05						
16:10						
16:15						
16:20						
16:25						
16:30						
16:35						
16:40						
16:45						
16:50						
16:55						
17:00						
17:05						
17:10						
17:15						
17:20						
17:25						
17:30						
17:35						
17:40						
17:45						
17:50						
17:55						
18:00						
18:05						
18:10						
18:15						
18:20						
18:25						
18:30						
18:35						
18:40						
18:45						
18:50						
18:55						
19:00						
19:05						
19:10						
19:15						
19:20						
19:25						
19:30						
19:35						
19:40						
19:45						
20:00						

詳しくは <http://www.bnl.gov/erl2015/>

# Plenary session (1)

M. Tigner ERL50年



## Outline

- I. Original Concept
- II. First Test
- III. Currently Operating Machines
- IV. Concepts for the Future
- V. Challenges to Realization: R&D Needs
- VI. Conclusion

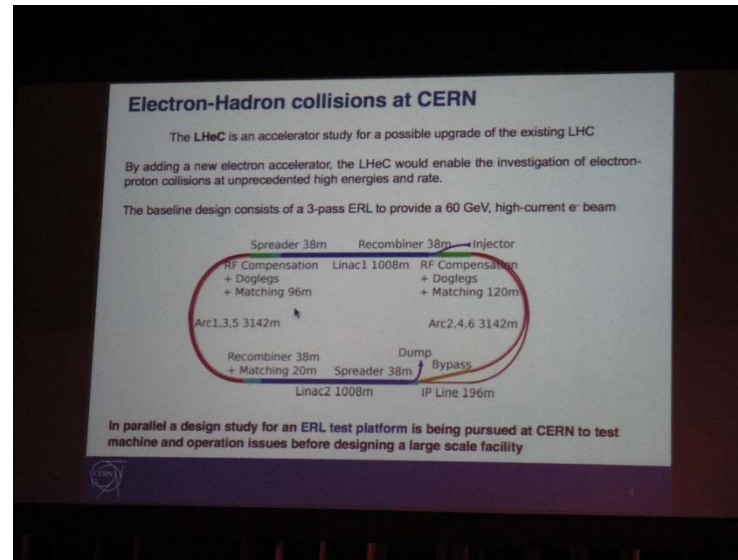

CERN test facilityは900MeVで3turnの計画

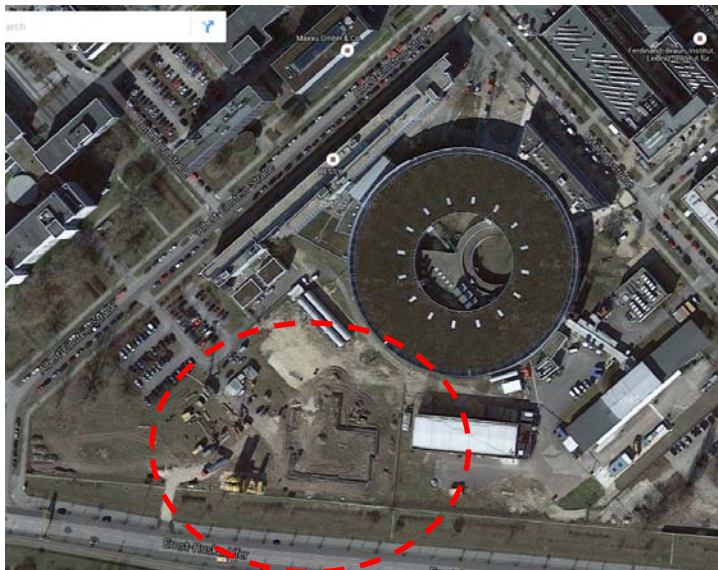

HZB: in construction

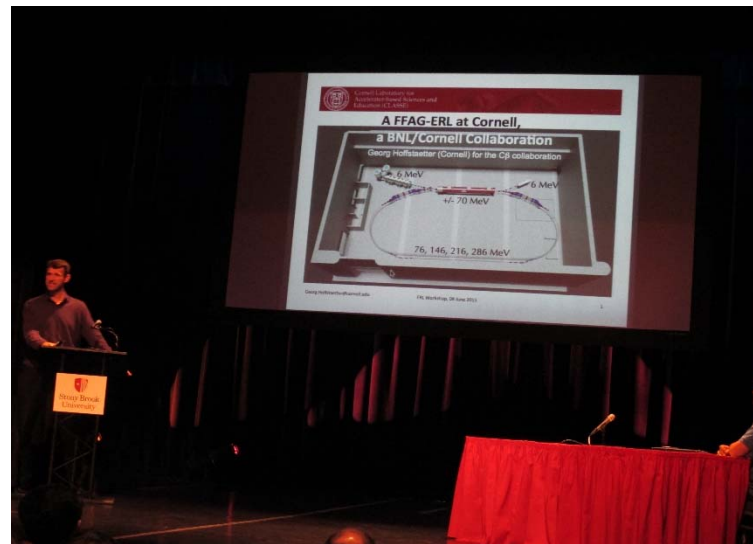

Cornell/BNL FFAG-ERL

CornellはBNLと一緒にFFAGをBaseにERLを行う予定。(細かいのは忘れた)同じビームラインにAlternating Gradientのマグネットで周回させる。まだ検討段階。

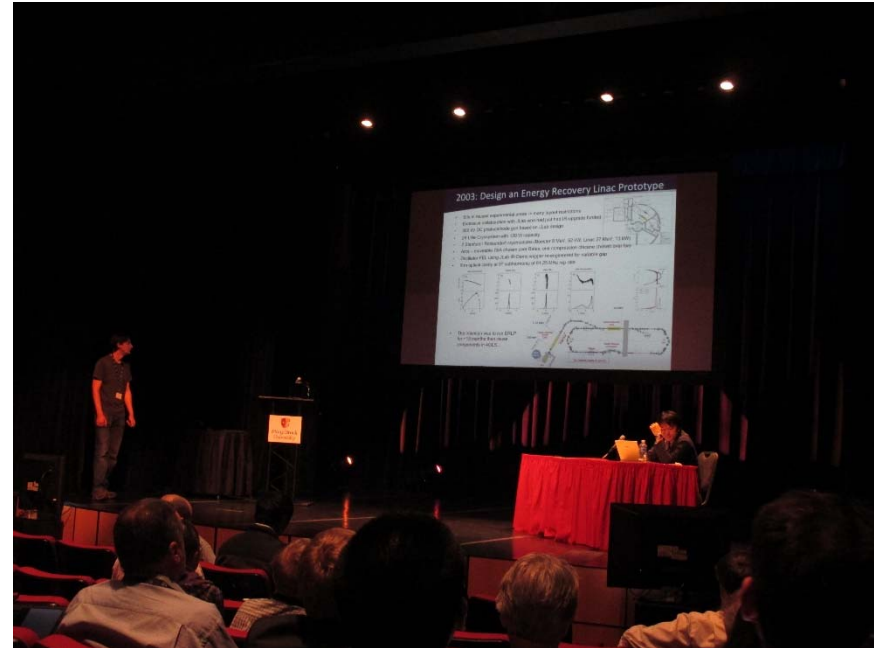
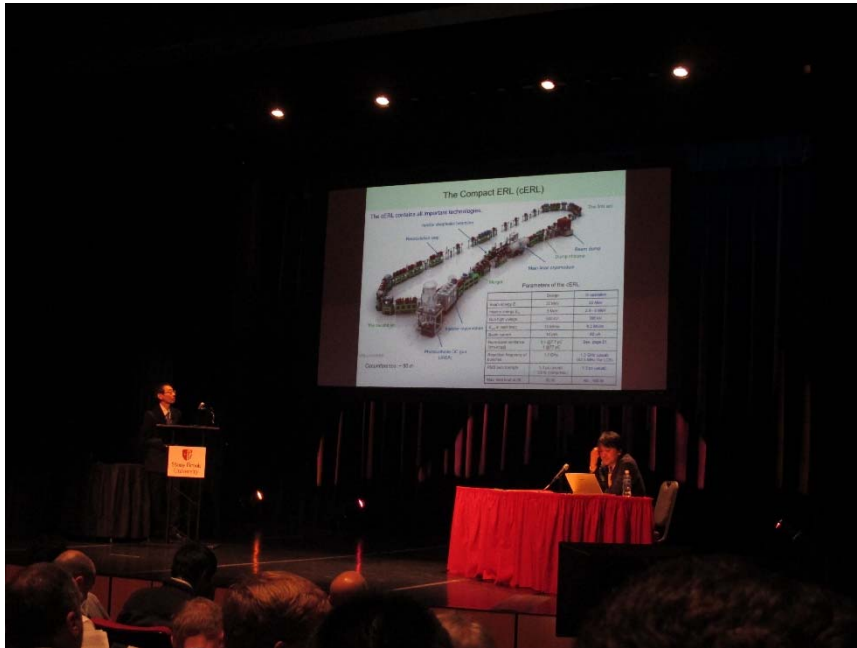

cERLの発表ではこの後のWGではビームを使って色々なことを調べたいということが議論されていた。(WG2 BDのsession)

DarasburyのALICE 10年では最初の黎明期から途中でのCW crymoduleの失敗、後半のTHzなどの実験の話など。He processもやっていたのは知らなかった。

中村さんからEUV-FELの話をした。10kWまで達成するパラメータをキチンと発表していた。質問はなかった(のが恐ろしい)が、後でASMLの人が一人来ていて、中村さんに後でずっと質問していたのが印象的だった。

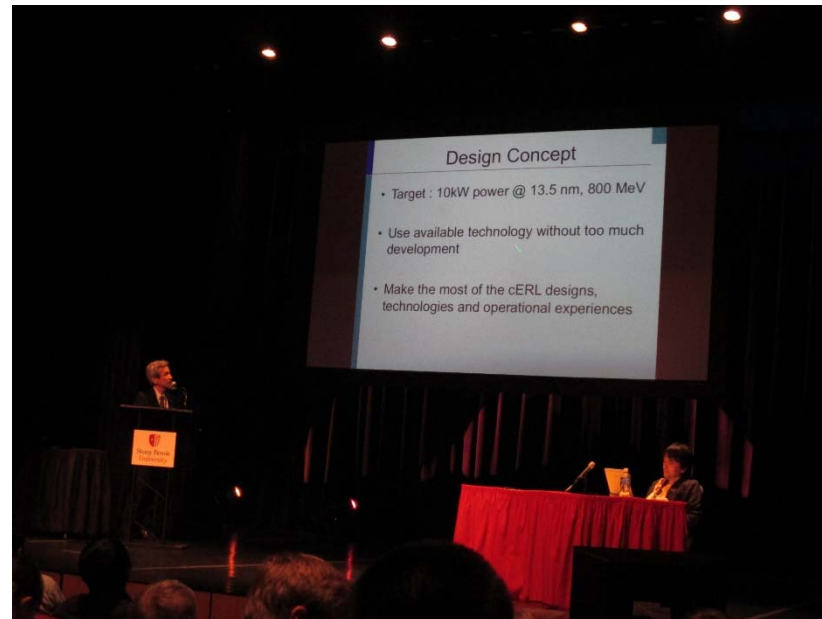

N.Nakamura  
EUV-FEL

# ERL2015 WG4: RF & superconducting RF for ERL SUMMARY

Conveners:

Hiroshi Sakai(KEK)

Erk Jensen(CERN)

2015.June.11 “WG4 SRF  
Challenges in ERLs”



# ERL2015 WG4: Charge

The WG4 charge is to identify the critical issues of each component in cryomodule construction, assembly works and beam operation for ERL. Especially, we need to evaluate what is the critical issues of SRF cryomodules for high current and high charge with low emittance beam operation. Following themes will be discussed in WG4.

- Recent progress of each lab for ERL from ERL2013
- Cavity & module design for ERL
- Cavity fabrication & testing
- HOM damping
  - HOM damper and coupler development for high current
  - HOM calculation
- RF control for stable beam operation
  - RF source
  - LLRF control
- SRF Gun
- High Q R&D

# Talk break down

institute	No. of Talks
BNL	2
KEK	3
HZDR	2
FNAL	1
IHEP	1
IMP (Jlab)	1

institute	No. of Talks
Cornell U.	2
Peking U.	2
Virginia U.	1
Colorado U.	1
TU Darmstadt	1
MHI	1

Total 18 talks contribute to WG4 session !  
Many thanks to the speakers !

# ERL2015 WG4: WG4 Prenary session



<u>June 8</u> <u>16:20-16:45</u>	<u>High-Q R&amp;D for SRF Challenge in</u> <u>ERLS</u>	<u>Fumio Furuta</u>	<u>Cornell</u> <u>University</u>
-------------------------------------	---	---------------------	-------------------------------------

## SRF challenge for High-Q:

- Pick up the topics of “High-Q R&D” for SRF challenge.
- Recent High Q R&D is the hot topic for SRF field and one of the critical issues for CW operation cavities
- This challenging approach give the higher gradient ERL operation.



# Optimization for highest-Q

Fumio Furuta

- High-Q cavity challenges on Cornell ERL and SLAC LCLS-II have been done successfully by the optimized combinations of  $R_{BCS}$  and  $R_{res}$  control.
- Different surface finishes require different flux controls to minimize  $R_{res}$ , especially on cool down procedures.

	Cornell ERL	SLAC LCLS-II
1.3GHz SRF cavity	7-cell	9-cell
Highest Qo in HT at 16MV/m, 2K	3.5e10	3.2e10
Estimated $P_{diss/cell}$ at 16MV/m, 2K	0.9W	0.9W
Surface finish	120C bake + HF rinse	N2-dope
Cool down	Slow cool with minimized $\Delta T$ over cavity	Fast cool with minimized longitudinal $\Delta T$ large verical $\Delta T$
Trapped flux effect	Not sensitive	High sensitive

9

High-Q of >3e10 at 2K in medium field is in hand now with high yield at horizontal test.

# ERL2015 WG4: WG2-WG4 joint session

<b>Jun. 9</b>	<b>14:00 – 15:40</b>	<b>Lecture Hall 2</b>
---------------	----------------------	-----------------------

<b>14:00-14:25</b>	<b>Investigations on Transverse Beam Break Up Using a Recirculated Electron Beam</b>	<b>T. Kuerzeder</b>	<b>TU Darmstadt</b>
<b>14:25-14:50</b>	<b>HOM-BBU Simulation for KEK ERL light Source</b>	<b>S. Chen</b>	<b>KEK</b>
<b>14:50-15:15</b>	<b>Linear Microbunching Gain Estimation Including CSR, LSC And Linac Geometric Impedances In Recirculation Machines</b>	<b>C.Y. Tsai</b>	<b>Virginia University</b>
<b>15:15-15:40</b>	<b>Study of CSR impact on electron beam in the JLab ERL</b>	<b>C. Hall</b>	<b>Colorado University</b>

## ERL Beam dynamics and SRF



WG2 summary

- HOM-BBU simulation
- Impedance issue to recirculating beam

[Thanks to the WG2 contribution to discuss above themes](#)

# ERL2015 WG4: WG1-WG4 joint session

Jun. 9	15:55 – 17:35	Lecture Hall 1
--------	---------------	----------------

15:55-16:20	Commissioning program for the 704 MHz SRF gun at BNL	W. Xu	BNL
<u>16:20-16:45</u>	<u>Commissioning and first RF results of the 2nd 3.5 cell SRF for ELBE</u>	<u>Andre .Arnold</u>	<u>HZDR</u>
16:45-17:10	First beam characterization of SRF gun II at ELBE with a Cu photocathode	J. Teichert	HZDR
17:10-17:35	Discussion		

 Other WG1 summary

## ERL Injectors and SRF

➤ SRF gun

- Present progress of SRF gun development

[Thanks to the WG1 contribution to discuss above themes](#)

# Commissioning program of the 704 MHz SRF gun at BNL

Wencan Xu

## ❖ **Building up:**

1. Mid. 2010: vertical cavity test in Jlab, reached 2.9 MV w/o cathode stalk.
2. Mid 2011: 500 kW CW fundamental power coupler conditioning.
3. 2011 to 2013: Installation of the whole cryostat; Preparation/commissioning the subsystems: cryo, LLRF, vac, instrumentation, cathode preparation system...

## ❖ **Commissioning:**

1. Nov. 2012 to Mar. 2013: Commissioned SRF gun cavity w/o cathode stalk inserted.
  - Demonstrated the SRF gun to be able to operate at 2.0 MV CW.
  - The amplitude stability is  $2.3 \times 10^{-4}$  rms and the phase stability is 0.035 deg rms.
2. Aug. to Oct. 2013: Commissioned SRF gun cavity with copper cathode stalk inserted.
  - Found operational parameters: 1.85 MV, 180 ms, 1 Hz - limited by multipacting in the stalk.
  - Design a new multipacting-free cathode stalk with Ta tip for high QE => high current electron beam.
3. May 28 to Jun. 18, 2014: Commissioning with Cs<sub>3</sub>Sb photocathode and dark current was observed.
  - Understood the reasons for no photoemission beam and resolved the issues;
  - Demonstrated that the SRF cavity's performance was not degraded by photocathode insertion.
4. Nov. 17, 2014 : First photoemission beam commissioning
  - Observed photoemission beam, measured beam parameters and cathode's QE.
5. March to April, 2014: Multipacting free cathode stalk
  - Demonstrate the multipacting-free cathode stalk is "Truly Multipacting-free".
6. June 1 to present, 2015: High charge beam commissioning with new cathode stalk.
  - 0.55 nC per laser pulse

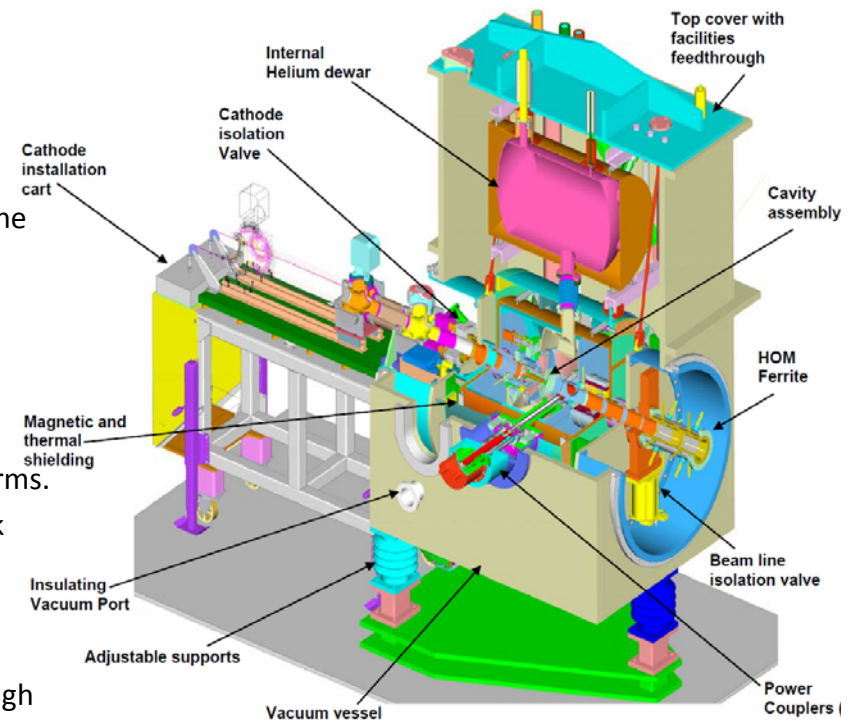

Nb cavity

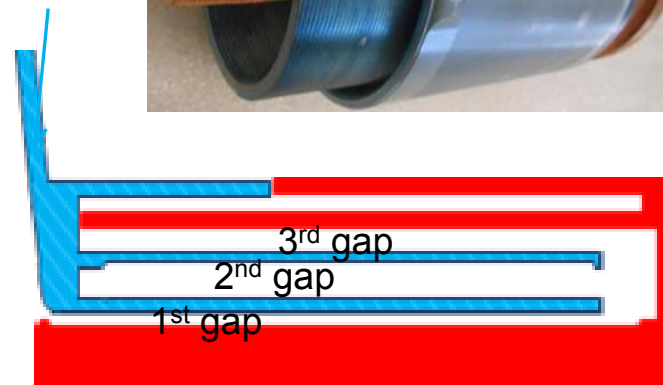

# First observed beam on Beam profile monitor

Wencan Xu

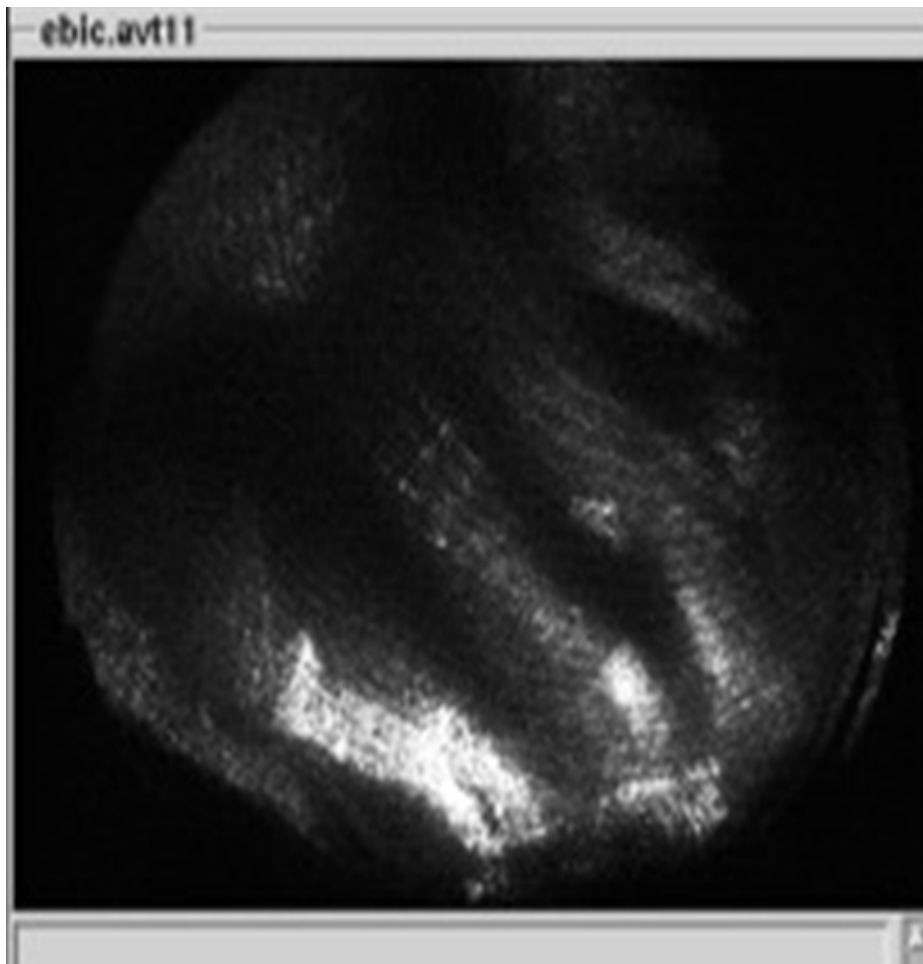

RF off

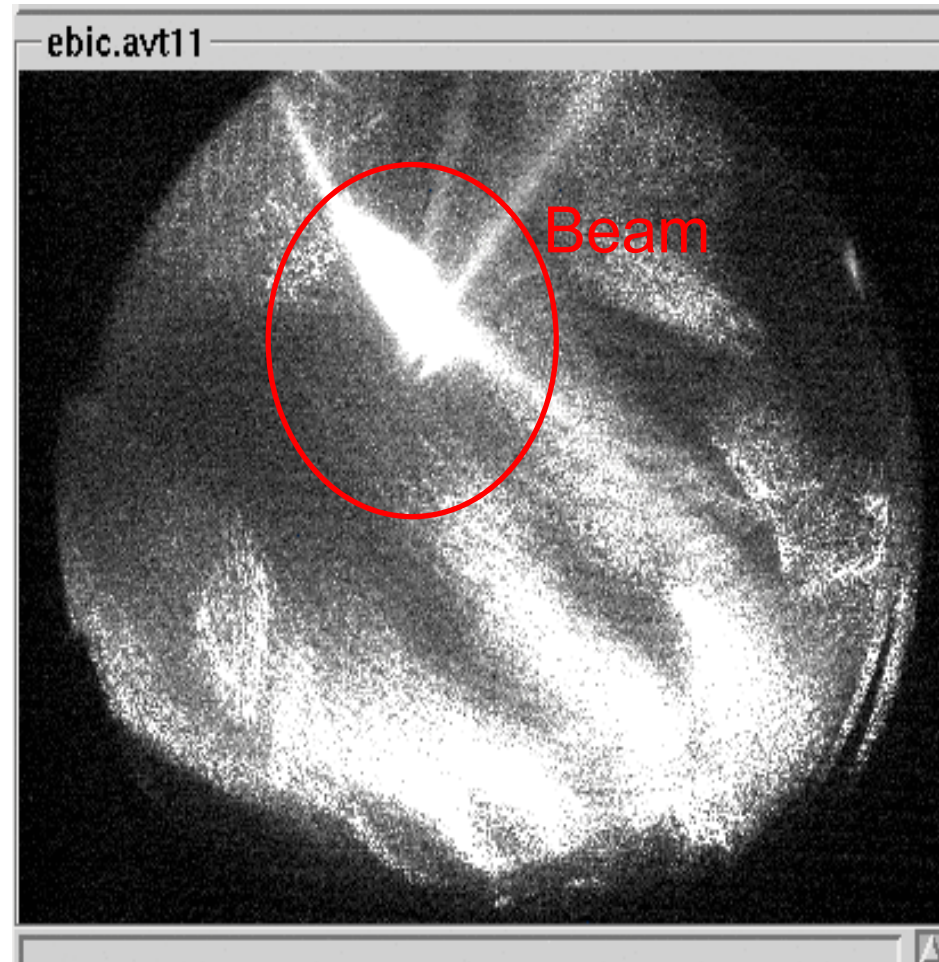

RF on

- Parameters: Laser: 6.08 Watt; RF: 1.2 MV, 500 ms;
- Beam: bunch charge: 7.7 pC, photoemission current 1  $\mu\text{A}$ , dark current: 38 nA;
- Focusing the beam with RT solenoid.

## 2<sup>nd</sup> ELBE SRF gun cavity & SRF test results (1)

Andre Arnold  
(HZDR)

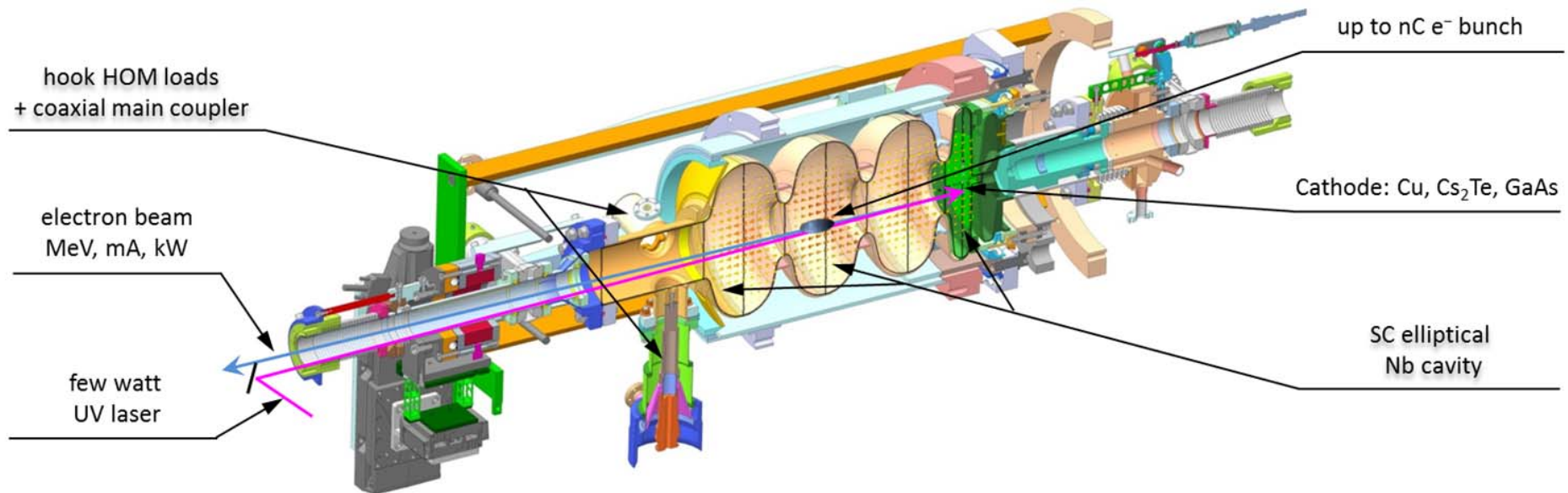

- still challenging to built and prepare extraordinary SRF gun cavities, **4 years for 1 cavity !**
- coldmass- + cryomodule assembly and cooldown at the ELBE LINAC **done within 6 month !**
- low power RF tests
  - external Q of FPC =  $9.3 \times 10^6$  corresponds to **BW = 140 Hz @ 1.3 GHz**
  - tuner resolution = **0.3 Hz/step**, total tuning range =  **$\pm 272$  kHz**, no hysteresis
  - relatively high pressure sensitivity = **155 Hz/mbar** but not critical
- high power RF tests
  - moderate microphonics, closed loop phase noise =  **$0.02^\circ$**  and amplitude stability =  **$1e-4$**
  - **6x higher** Lorentz force detuning than TESLA 9 cell cavities  
(**caused only by half cell**, critical for our small bandwidth)

# 2<sup>nd</sup> ELBE SRF gun cavity & SRF test results (2)

Andre Arnold  
(HZDR)

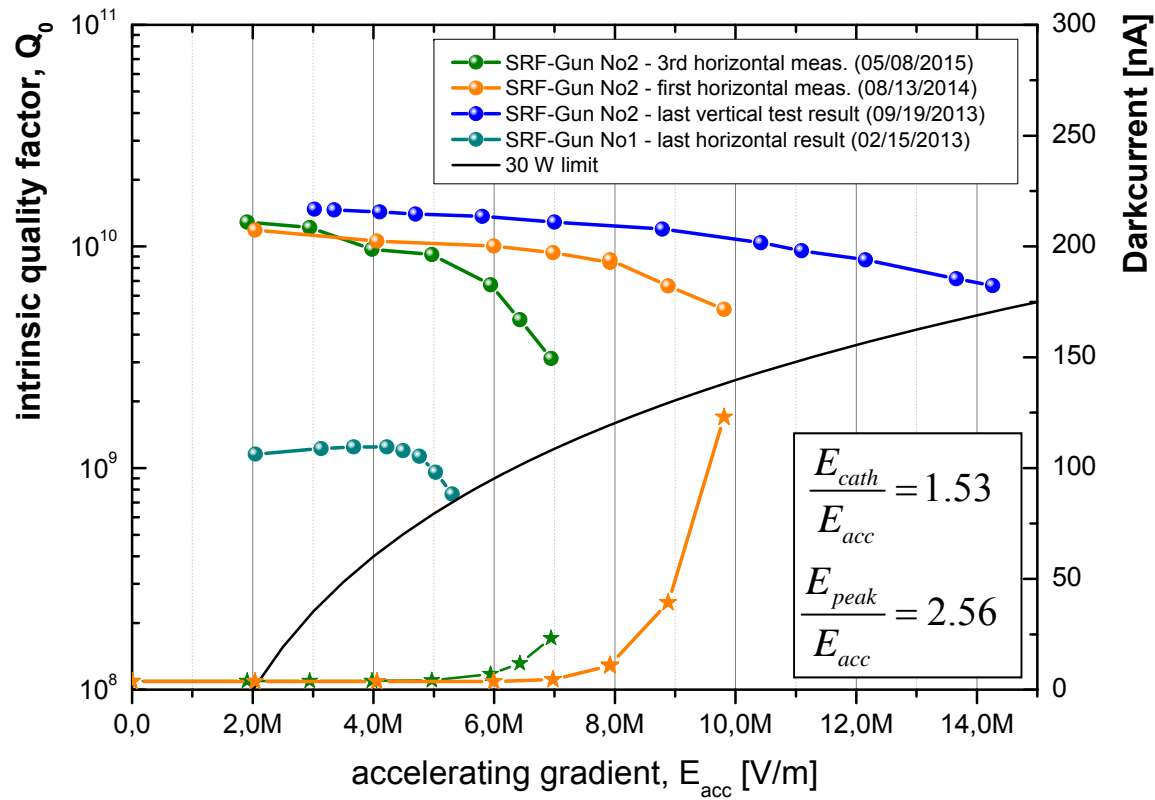

## QvsE

- **30% loss due to FE** compared to last vertical test
- **Tremendous loss after Cs<sub>2</sub>Te cathode** transfer due to particle contamination of the cavity
- But still better than SRF gun I

## Investigation of FE source

- Analysing of spatial  $\gamma$ -ray distribution points to half cell
- QvsE for all 4 TM<sub>010</sub> passband modes point to 1<sup>st</sup> or 2<sup>nd</sup> iris
- Comparison of simulated and measured dark current spectra points to **first iris as FE source**

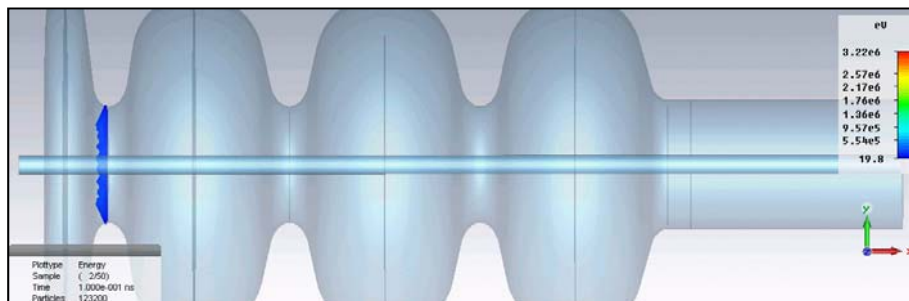

**1<sup>st</sup> Contamination risk of SRF gun cavities by NC cathodes is not yet eliminated !!**

**2<sup>nd</sup> More effort (money) in fabrication needed to increase yield of usable cavities !!**

# ERL2015 WG4: WG4-session 1 & 2

Jun. 10

10:45 – 12:25 & 14:00 – 15:40

Lecture Hall 2

Overview of the progress after ERL13 and  
review of the cavity and cryomodule test:  
Cavity design & test and fabrication for ERL:

- Laboratory talks
- Cavity design for high current & its performance
  - Module design for ERL & its performance
    - Operation experiment of cryomodule
- Cavity design for high current ERLs & its performance
  - Cavity fabrication for mass production
    - Cavity design for kicker cavity
    - SCRF related development
  - HOM damper and coupler development
  - Input coupler development



# ERL2015 WG4: WG4-session 1 & 2

<b>Jun. 10</b>	<b>10:45 – 12:25 &amp; 14:00 – 15:40</b>	<b>Lecture Hall 2</b>
----------------	--	-----------------------

<b><u>10:45-11:10</u></b>	<b><u>Cornell's ERL main linac cryomodule: design, construction and results</u></b>	<b><u>Ralf Eichhorn</u></b>	<b><u>Cornell University</u></b>
<b><u>11:10-11:35</u></b>	<b><u>Operational experience of CW SRF Injector and Main linac cryomodules at the Compact ERL</u></b>	<b><u>Hiroshi Sakai</u></b>	<b><u>KEK</u></b>
<b><u>11:35-12:00</u></b>	<b><u>The development of the high current superconducting cavity at IHEP</u></b>	<b><u>Zhenchao Liu</u></b>	<b><u>IHEP</u></b>
<b><u>12:00-12:25</u></b>	<b><u>Recent Progress in SRF Acceleration Technology at Peking University</u></b>	<b><u>Senlin Huang</u></b>	<b><u>Peking University</u></b>
<b><u>14:00-14:25</u></b>	<b><u>SRF cavities for high current ERLs</u></b>	<b><u>Wencan Xu</u></b>	<b><u>BNL</u></b>
<b><u>14:25-14:50</u></b>	<b><u>Development for mass production of superconducting cavity by MHI</u></b>	<b><u>Kohei Kanaoka</u></b>	<b><u>Mitsubishi Heavy Industries (MHI)</u></b>
<b><u>14:50-15:15</u></b>	<b><u>Harmonic Resonant Kicker Design for the MEIC Electron Circular Cooler Ring</u></b>	<b><u>Yulu Huang</u></b>	<b><u>IMP (Jlab)</u></b>
<b><u>15:15-15:40</u></b>	<b><u>Discussion</u></b>		

# Finishing the MLC @Cornell

Ralf Eichhorn (Cornell U.)

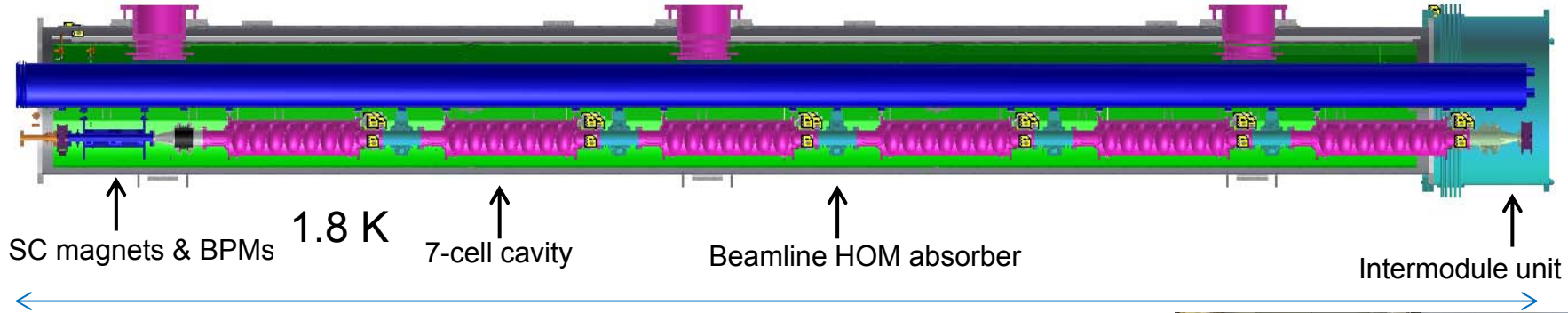

nominal length: 9.8 m

Prototype of a Linac Cryomodule for the Cornell ERL:

- six packages of 7-cell cavity/Coupler/tuner
- five regular HOMs/  
two taper HOMs

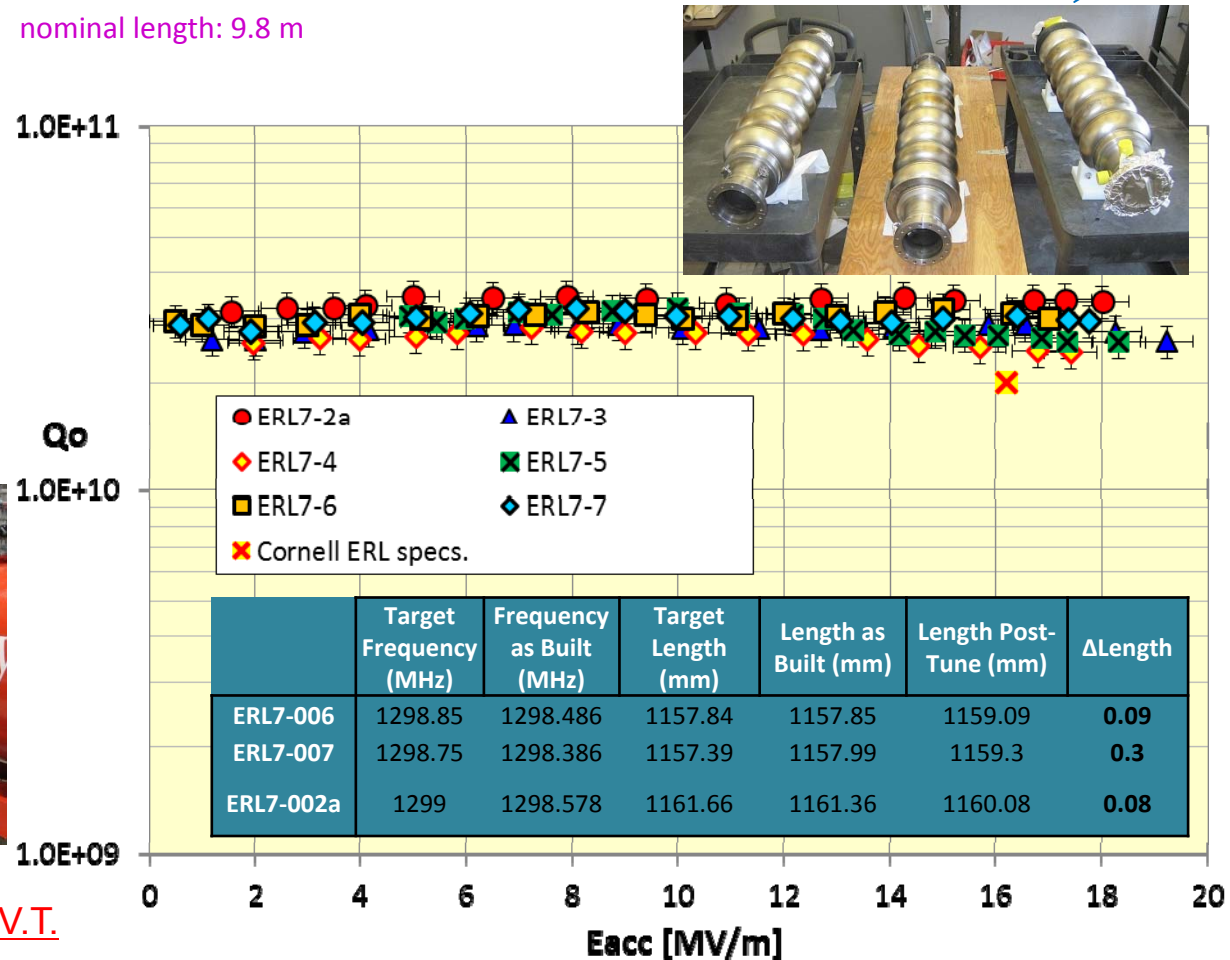

High-Q of all cavities.were achieved in V.T.

# Cornell HOM Beamline Absorbers

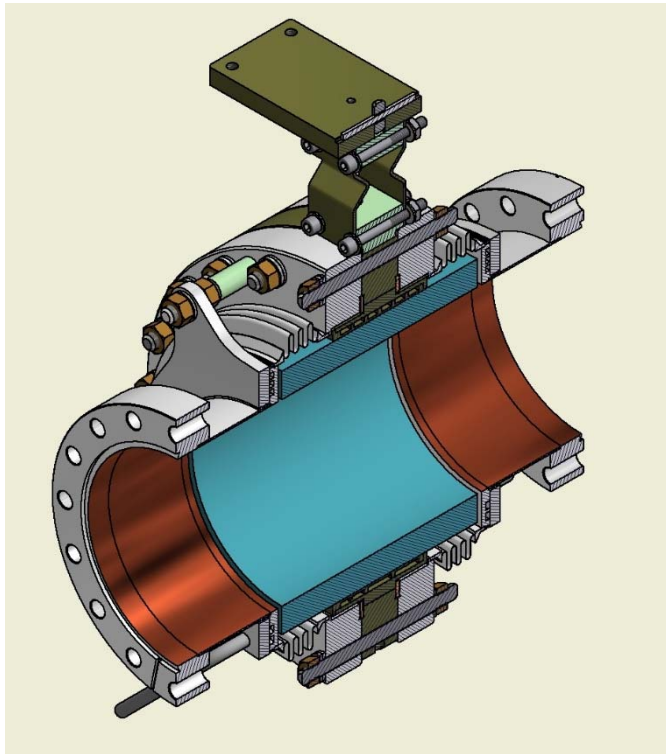

**HTC-2: No HOM Absorbers**  
**HTC-3: With HOM Absorbers**

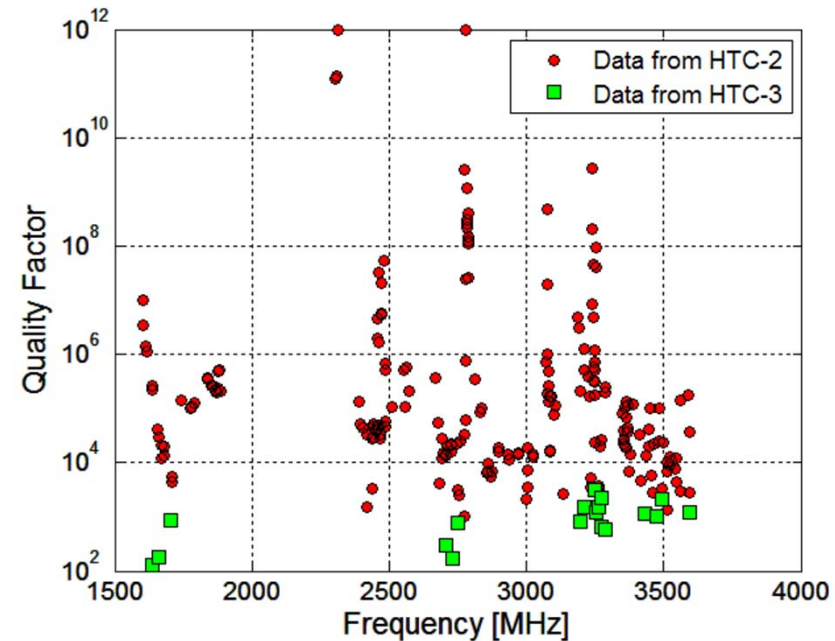

Current, bunch length	$\Delta T$ (beam pipe behind Abs.) coated/uncoated	$\Delta T$ (80K gas temp) coated/uncoated	$\Delta T$ (80K absorber temp) coated/uncoated	$\Delta T$ (5K flange next to cavity) coated	$\Delta T$ , beam pipe to cavity coated/uncoated
25 mA, 3.0 ps	0.075/0.075	1.14/0.82	1.02/0.975	0.007	0.076/-0.005
40 mA, 3.4 ps	0.2475/0.335	2.95/2.16	2.72/2.53	0.021	0.179/0.009
40 mA, 2.7 ps	0.2975/0.425	3.00/2.22	2.772/2.63	0.027	0.203/0.014

More than 40mA with 2.7ps was achieved to suppress HOM with HOM damper !

# OPERATIONAL EXPERIENCE OF CW SRF INJECTOR AND MAIN LINAC CRYMODULES AT THE COMPACT ERL (cERL)

## Compact ERL Layout

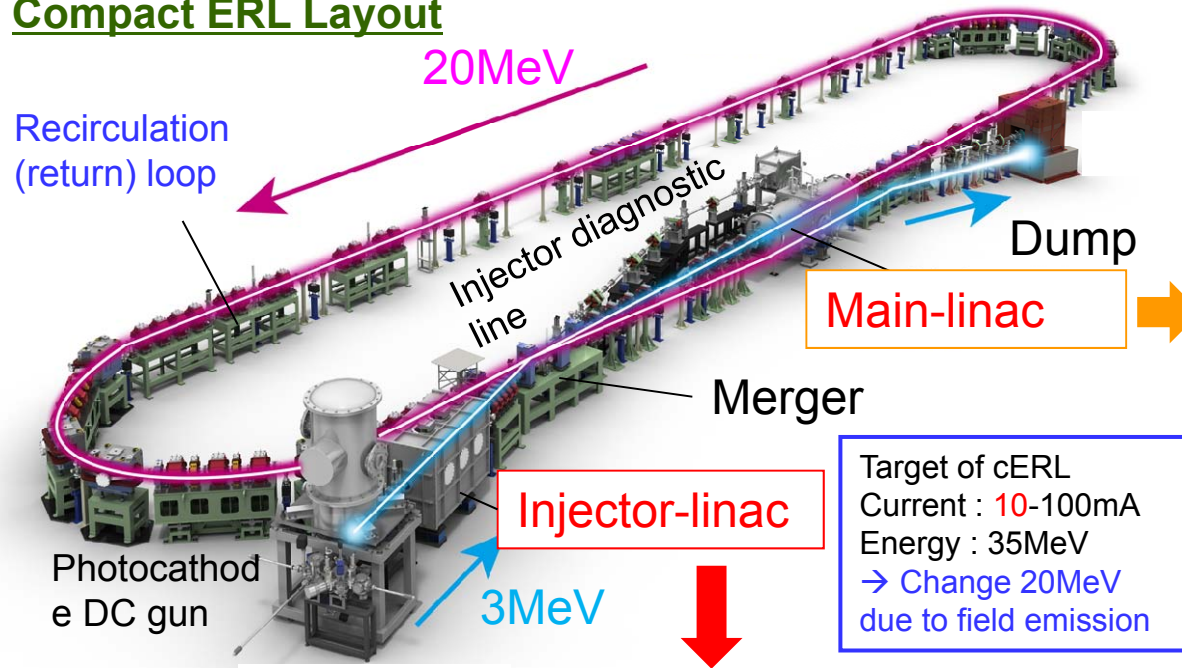

## Main linac module

HOM damped (for 100mA circulation to suppress HOM-BBU in design)  
9-cell cavity (ERL-model2) × 2

RF frequency: 1.3 GHz  
Input power : 20kW CW (SW)  
 $E_{acc}$ : 15 MV/m (design)  
Unloaded-Q:  $Q_0 > 1 \times 10^{10}$

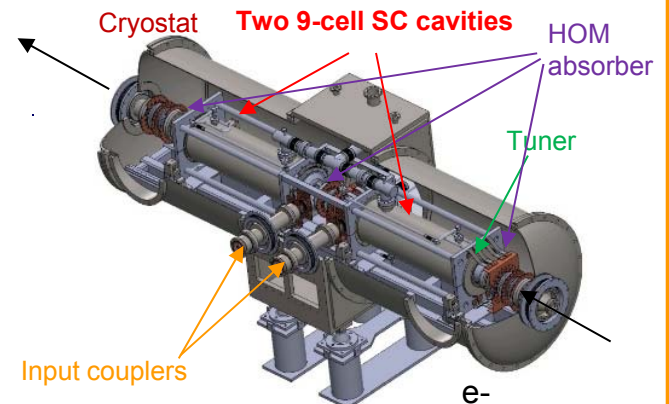

Requirement was satisfied at V.T. Heavy F.E was met @9-10MV/m after string assembly.

## Injector module

2-cell cavity × 3  
Double coupler

RF frequency: 1.3 GHz  
Input power :  
10kW/coupler (10mA, 5MeV)  
180kW/coupler (100mA, 10MeV)  
 $E_{acc}$ : 7.6MV/m (5MeV)  
15MV/m (10MeV)  
Unloaded-Q:  $Q_0 > 1 \times 10^{10}$

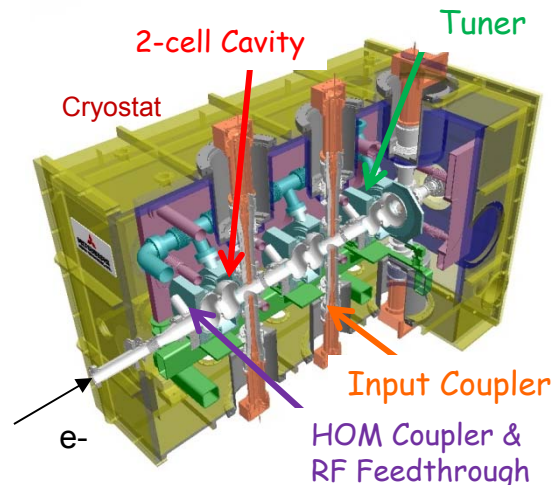

Requirement was satisfied at V.T and for initial 10mA requirement .

## \* Progress from ERL2013

Start beam operation with ERL return loop.

- Completed construction in Dec. 2013.
- Commissioned started in Dec. 2013.  
20MeV 10uA (Dec.2013 – Jun.2014)  
20MeV 100uA (Jan.2015 – Jun.2015)

# Q-value history of Main linac (ML)

Hiroshi Sakai

(from high power test to beam operation for 2.5 years)

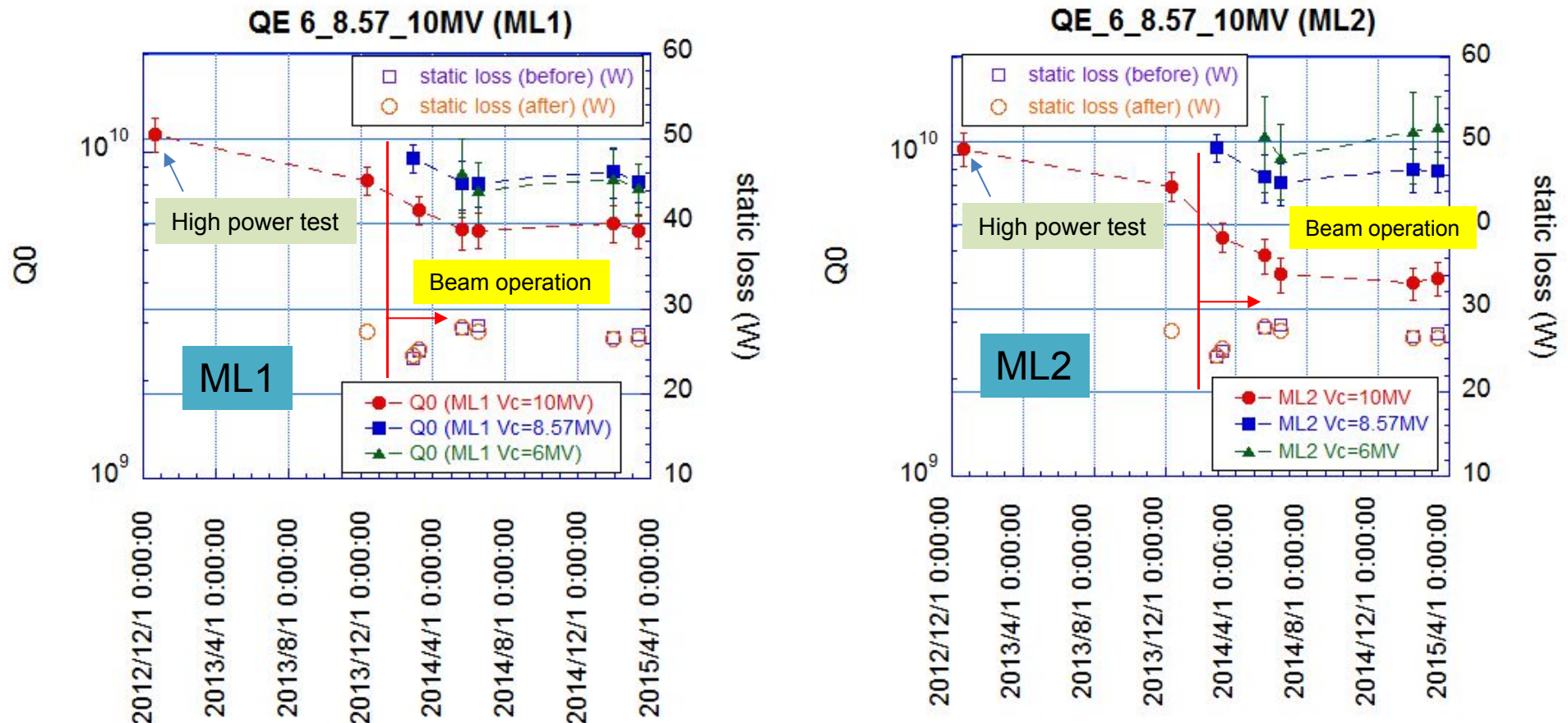

- We kept stable beam operation by digital LLR Fsystem ( $\Delta A/A < 0.01\%$ ,  $\Delta\theta < 0.01$  deg) and suppressed the microphonics.
- Several trips were observed on a year. No crucial hardware trouble, for example, come from miss operation of CW beam & or quench was met by fast & sophisticated ITL system to beam and RF.
- We met the Q degradation & radiation increase during beam operation on ML. We apply pulse processing pragmatically. Now we keep stopping cavity degradation. (ML1:200mSv/h, ML2 80mSv/h)
- We plan to make the new cryomodule with four 9cell cavities to overcome field emission problem.

# Slotted High Current Cavity HOMs' Damping Comparison

Why not open the damping structure **on the cell!** →

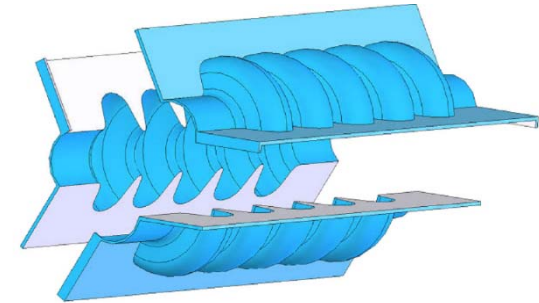

F (GHz, with covers)	Measured Value		F (GHz, without covers)	Calculated Value	
	Q <sub>L</sub> (with covers, still have field leak)	Q <sub>L</sub> (≈Q <sub>e</sub> , without covers)		Q <sub>e</sub> (without covers)	F (GHz)
1.524	560	x	x	5.2	1.525
1.5312	714	x	x	-	-
1.5926	624	x	x	-	-
1.5979	606	100	1.599	2.17	1.599(TE <sub>111</sub> )
1.677	1037	x	x	5.74	1.676
1.68	995	x	x	-	-
1.713	94	x	x	-	-
1.7526	1192	x	x	-	-
1.7492	1280	x	x	20.4/8.8	1.754/1.747
1.794	1312	x	x	-	-
1.8405	2047	344	1.842	446	1.855(TM <sub>110</sub> )
1.9	445	x	x	-	-
1.973	714	x	x	15.9	1.973
2.052	470	x	x	5.43	2.043
2.086	615	x	x	15.2	2.093
2.184	531	172	2.173	14.2	2.175
2.1985	321	x	x	-	-
2.254	1450	x	x	20.7	2.252
2.324	1990	2136	2.324	185961	2.326 *
2.365	1224	x	x	-	-
2.4	1071	630	2.4	-	-
2.437	800	667	2.437	105.1	2.439 *

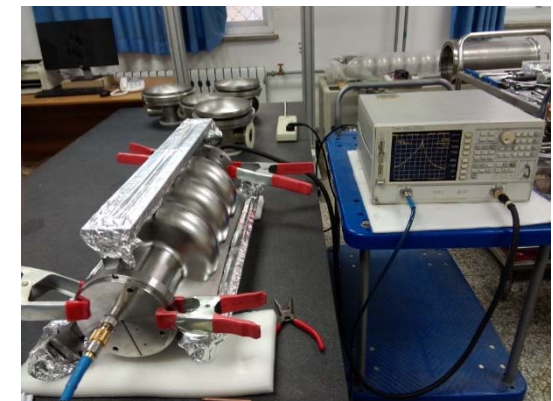

\*Notes on TABLE III: Many HOMs disappeared in the network analyzer when opening the waveguide port as the Q<sub>L</sub> of these mode decreased below 10 or so. These modes are depicted by "x". Since there are several calculated modes around the measured frequency or the frequency shift between measured frequency and calculated frequency is large, we use "-" to depict. \* depicts quadruple mode.

June 24, 2015

# Conclusion

- A 1.3 GHz 3-cell slotted cavity prototype has been fabricated.
- The cavity was processed at the standard procedure for SC cavity at IHEP.
- Room temperature RF test shows the slotted cavity has very high damping on HOMs.
- 4.2K vertical test was carried out and the cavity show great potential on ERL application
- 2K vertical test will be done soon



# DC-SRF Photoinjector is in Stable Operation @PKU

★ Stable operation of DC-SRF photoinjector has been achieved since 2014.

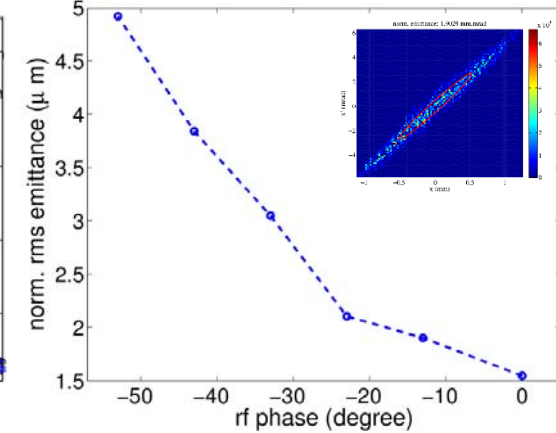
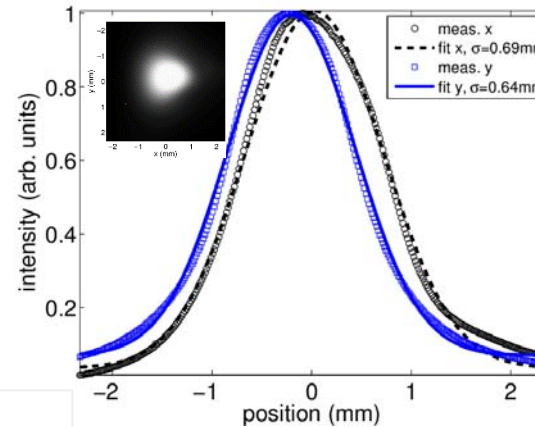
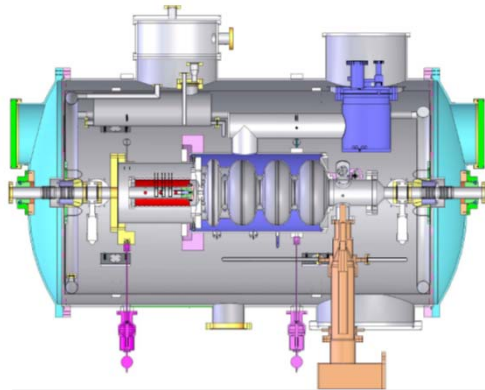

### ▲ Beam profile

### ▲ Emittance

The beam has been used to generate THz superradiant undulator radiation. ▼

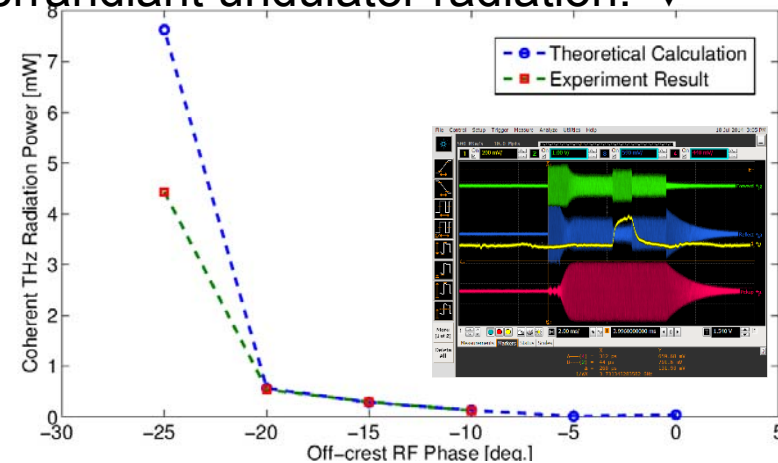

E-beam energy: 2.8-4 MeV  
 Bunch charge: 5-50 pC  
 Bunch rep. rate: 0.1625-81.25 MHz  
 Macro pulse length: 1 ms -CW  
 Norm. trans. emittance:  $\sim 2 \mu\text{m}$



Beam line



# 25 MeV Straight Section is Under Construction

- \* Assembling of 2x9-cell cryomodule will be done before the end of this summer.
- \* Beam loading experiments will be carried out this year.

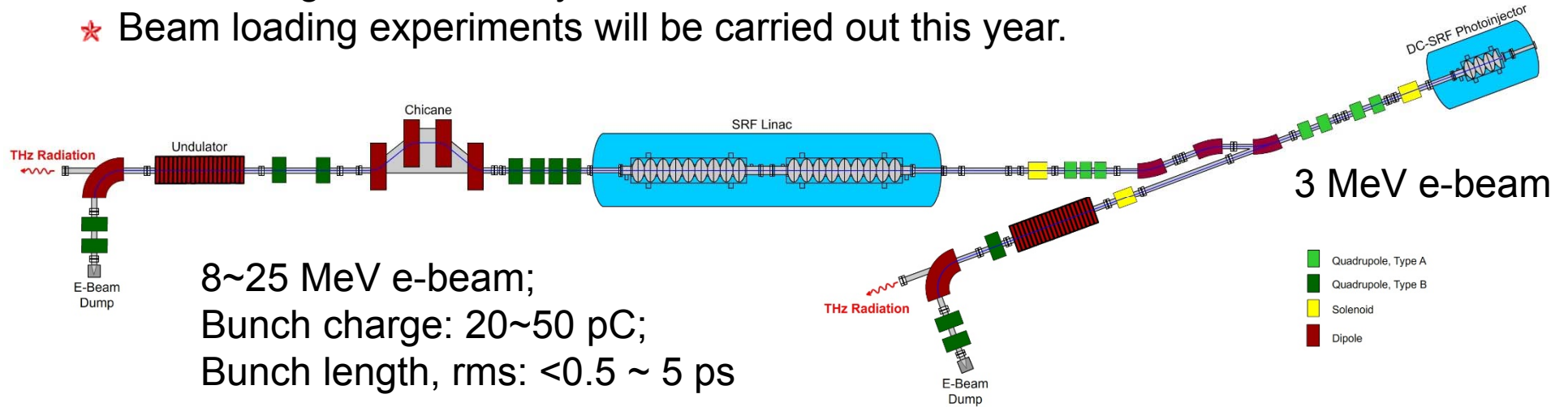

▼The cryomodule in position



06/10/2015

▼Existing large-grain cavities

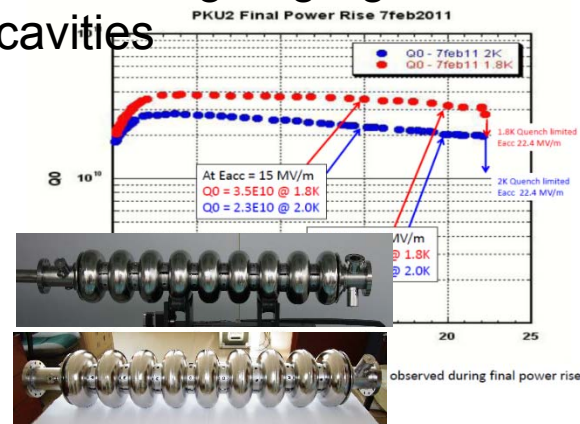

ERL2015, Stony Brook, NY

▼ Cavity tuners ready

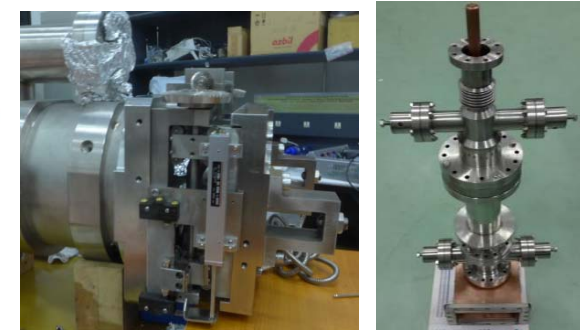

RF couplers tested ▲

25

# High current cavities at BNL

Wencan Xu

- HOM is the main concern for high current ERL machines, which includes HOM-induced transversal and longitudinal BBU and HOM power. The cavity optimization should address these effects.
- There are 3 high current cavities at BNL: a 704 MHz BNL1 cavity for R&D ERL, a 704 MHz BNL3 cavity for conventional lattice ERL eRHIC and CEC POP project (the cryomodule will commissioning during next RHIC run), and a 422 MHz BNL4 cavity for FFAG lattice ERL eRHIC (a 3-cell prototype cavity will be made and its performance will be study).

Parameters	BNL 1	BNL 3	BNL3_scale	BNL 4
Frequency [MHZ]	704	703.87	422	422.2
beta	1	1	1	1
Cells No.	5	5	5	5
Geometry Factor	225	283	283	273
(R/Q)/cell [ $\Omega$ /cell]	80.8	101	101	100.6
E <sub>peak</sub> /E <sub>eacc</sub>	1.97	2.46	2.46	2.27
B <sub>peak</sub> /E <sub>eacc</sub> [mT/MV/m]	5.78	4.26	4.26	4.42
Coupling factor [%]	3.00	3.02	3.02	2.83
Length with HOM damper (cm)	272	160 (eRHIC)	267	256
Beam pipe radius (mm)	120	110	183	180
Radius after tapered (mm)	N/A	50	83	80
First HOM frequency (MHz)			483	498

# HOM damping

Wencan Xu

- HOM damping for the whole HOM spectrum is a challenge for high current ERLs. Damping 7.8 kW per cavity is required for full luminosity eRHIC and two types (coaxial-line and waveguide) of HOM damper will be used.
- HOM damping scheme will be tested with the prototype cavity at 2K.

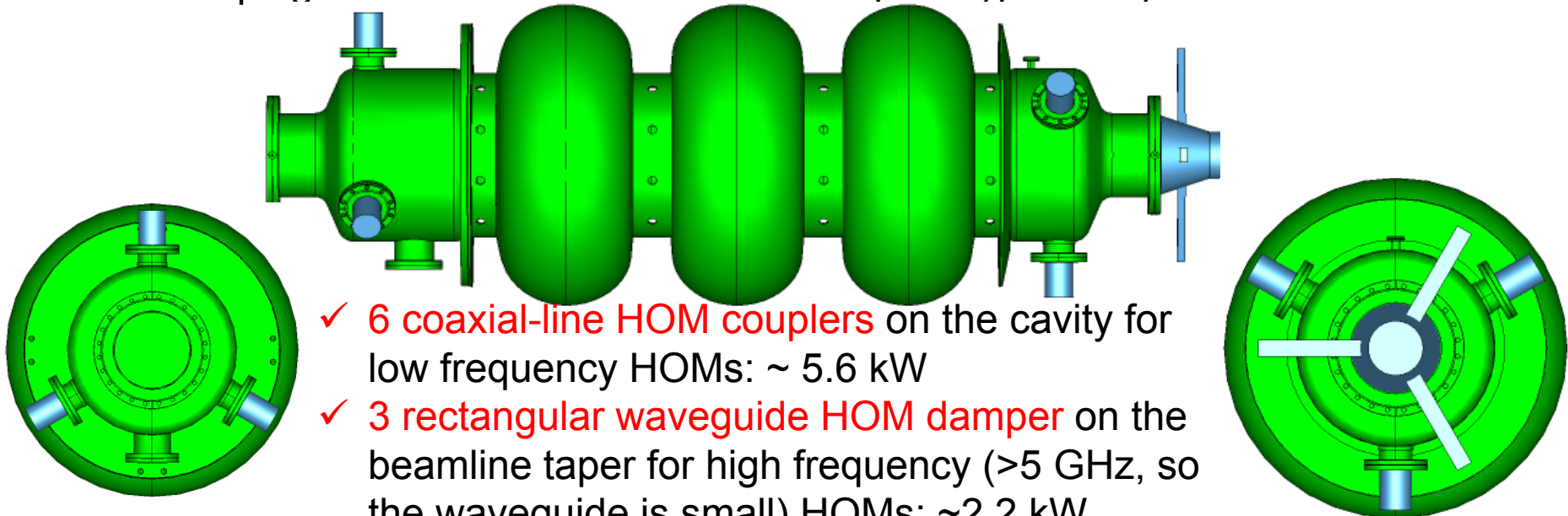

- ✓ **6 coaxial-line HOM couplers** on the cavity for low frequency HOMs:  $\sim 5.6$  kW
- ✓ **3 rectangular waveguide HOM damper** on the beamline taper for high frequency ( $>5$  GHz, so the waveguide is small) HOMs:  $\sim 2.2$  kW
- ✓ Preliminary results show encouraging performance of this damping scheme

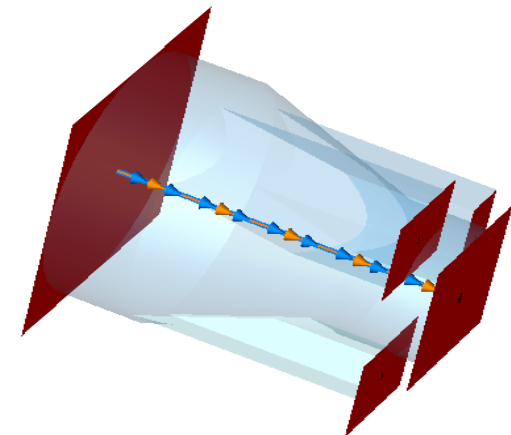
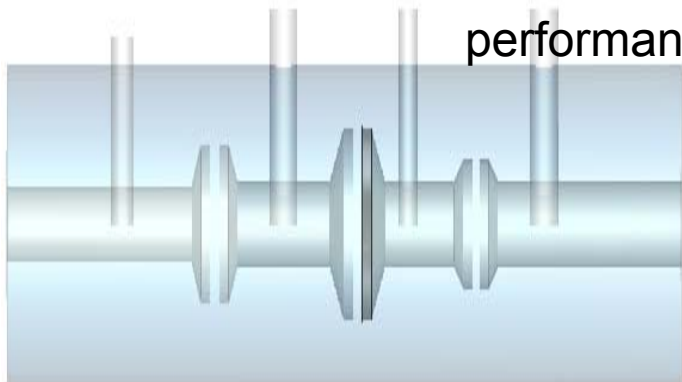

# Summary (MHI's work for KEK cERL)

**Kohei Kanaoka**

KEK cERL **Two cryomodule made by MHI works well**

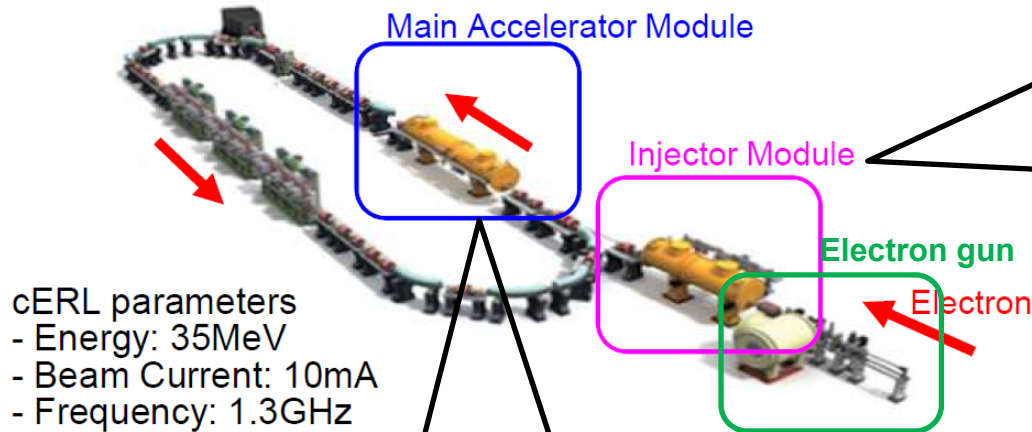

## Injector Module (2-cell cavity × 3)



## Main Accelerator Module (9-cell cavity × 2)



## SRF electron gun (For the future)

STEP1; Design of the shape of the cavity

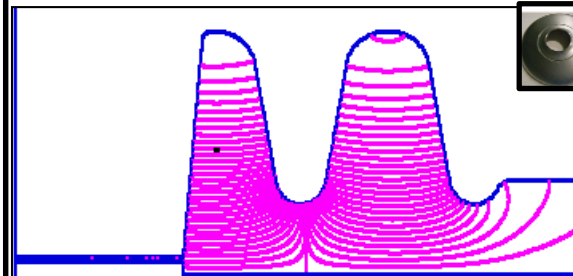

STEP2; Prototype#1

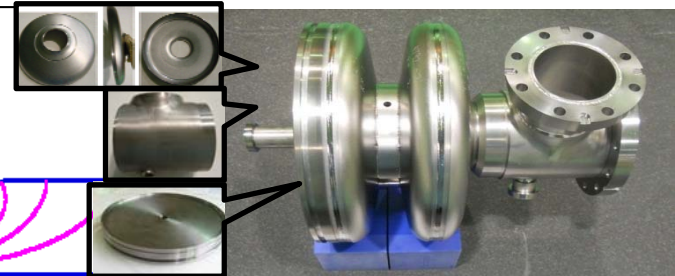

STEP3; Study of Prototype#2

- Choke structure
- Coupling calculation of Input coupler etc.

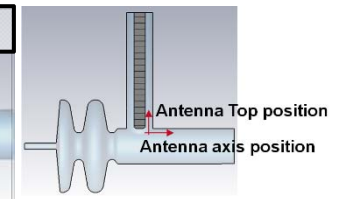
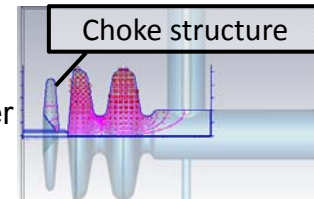

# Summary (MHI's developing activities for mass-production etc.) Kohei Kanaoka

## ■ Laser Beam Welding for the stiffener ling

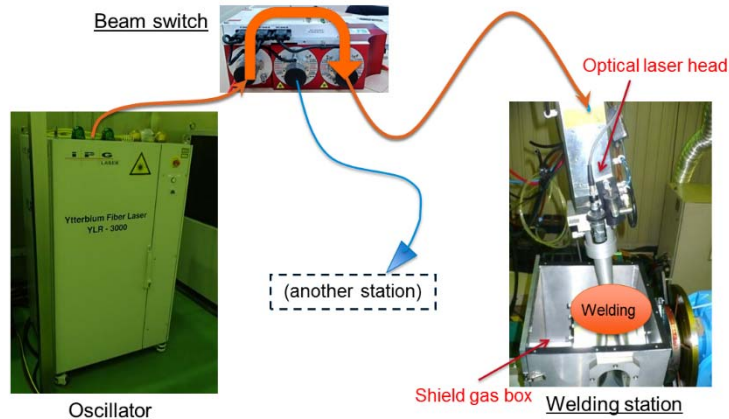

## ■ EBW Four 9-cell cavities in one batch

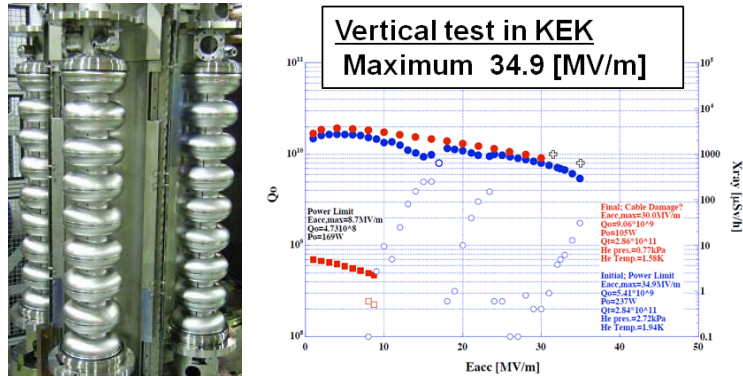

## ■ Seamless dumbbell



## ■ Reducing the number of parts Unification of parts

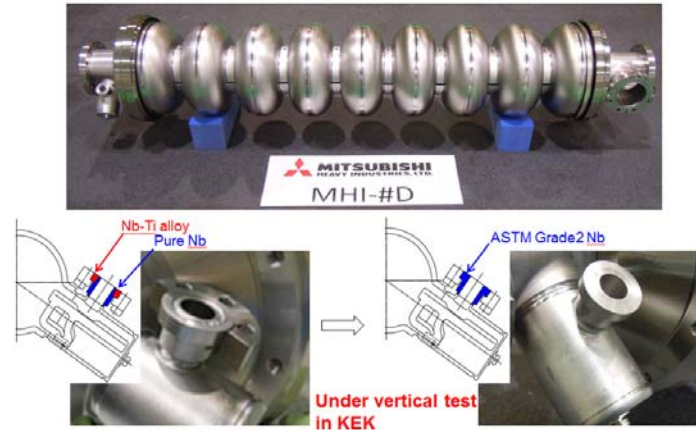

## ■ RRR measurement of Cu electroplating sample

For High power input coupler  
⇒ High electric conductivity  
⇒ Low thermal conductivity

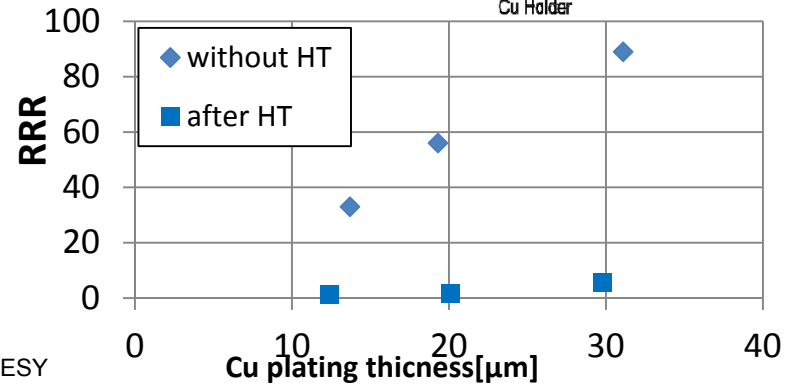
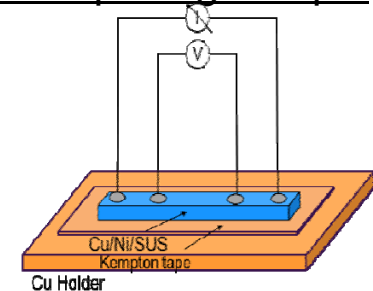

Reference;  
H.Sakai,  
TTC2014@DESY

# Ultra-Fast Harmonic Resonant Kicker Design for the MEIC Electron Circular Cooler Ring

Yulu Huang

MEIC Future High  
Luminosity Upgrades

Yulu Huang

Need High Current  
(~1.5A)

Electrons circulate 25 Turns in circulator ring, thus the current in the source and linac can be reduced by a factor 25.

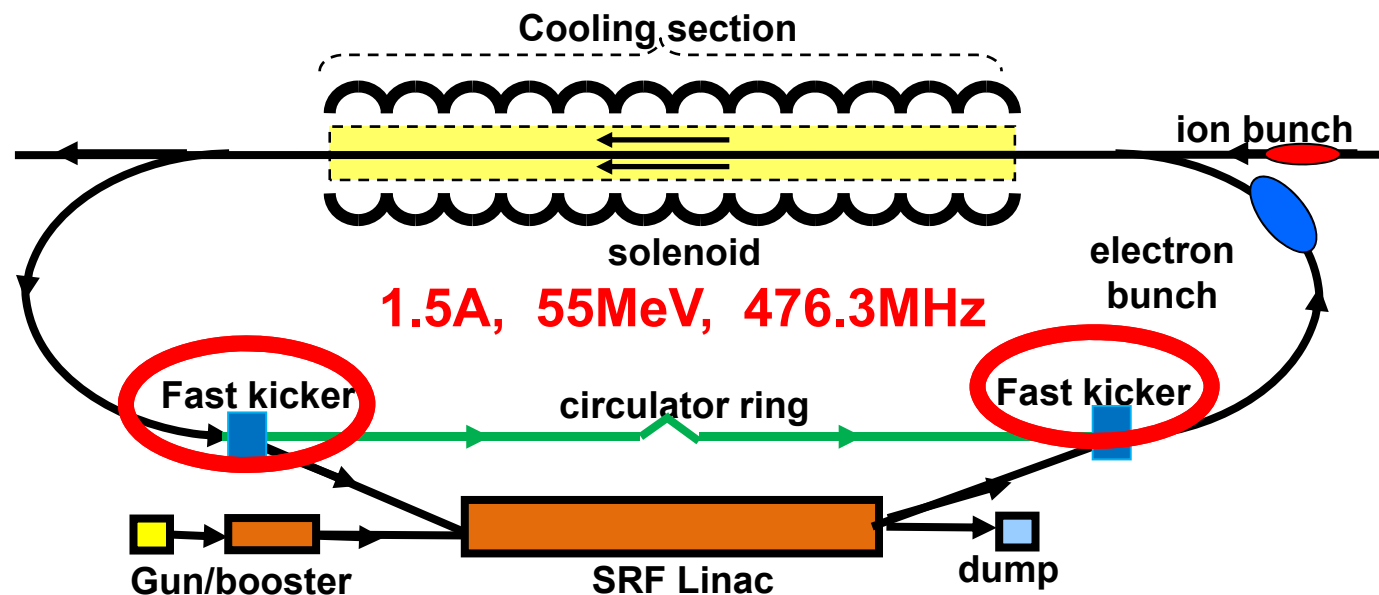

- Periodically kick 1 in every 25 bunches
- Ultra-fast, 2.1 ns
- 55kV (1 mrad kick angle)

0.06A, 55MeV, 19.052MHz (476.3/25)

(bunch repetition frequency)

# 4 Cavities with 10 Harmonic Modes to Kick Every 10<sup>th</sup> bunch in a 476MHz bunch train

Yulu Huang

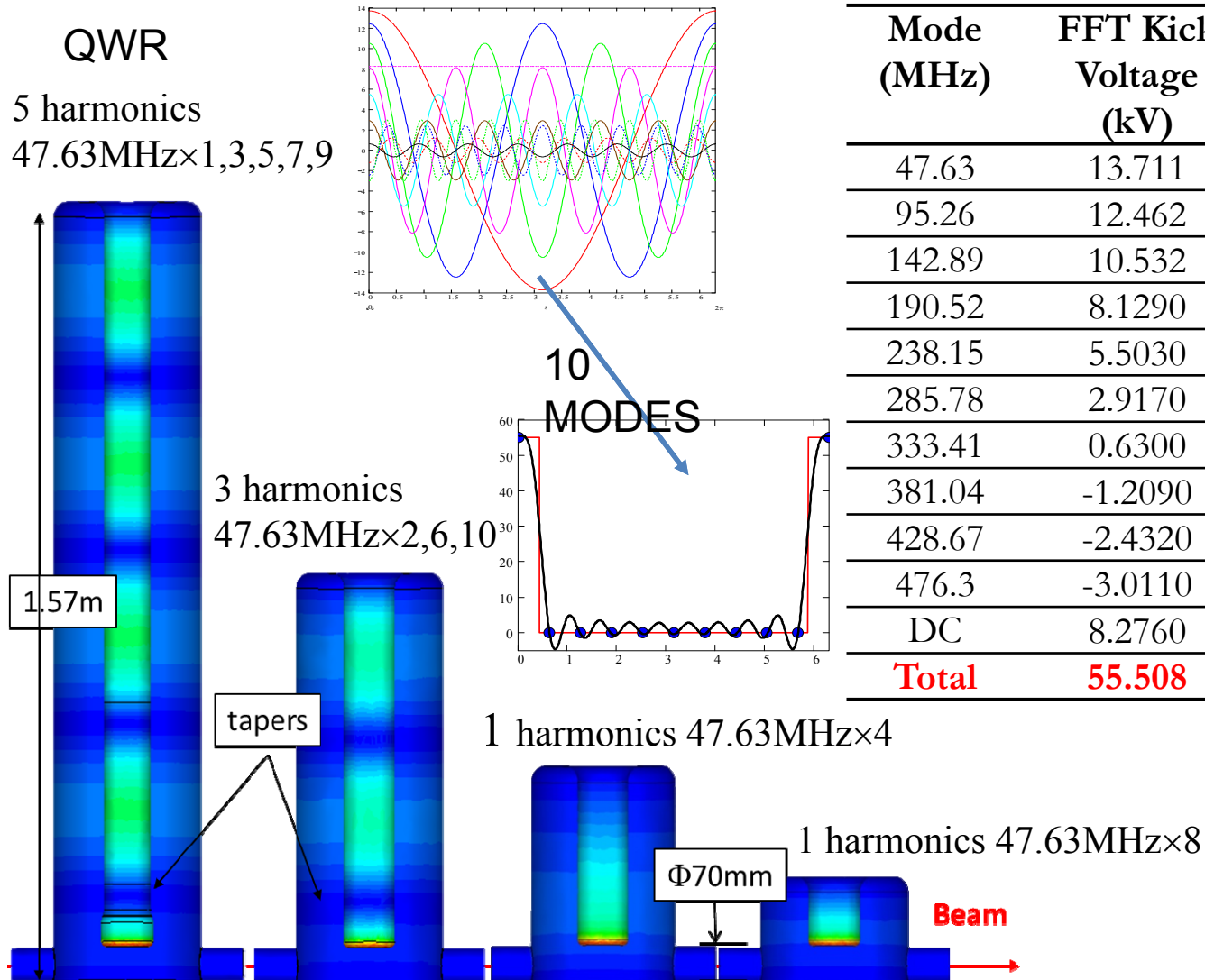

Mode (MHz)	FFT Kick Voltage (kV)	CST Trans. Shunt Impedance (Ω)	Dissipated Power (W)
47.63	13.711	7.13E6	26.37
95.26	12.462	1.14E7	13.62
142.89	10.532	4.09E6	27.12
190.52	8.1290	1.35E7	4.89
238.15	5.5030	3.14E6	9.64
285.78	2.9170	6.09E6	1.40
333.41	0.6300	2.65E6	0.15
381.04	-1.2090	1.65E7	0.09
428.67	-2.4320	2.40E6	2.46
476.3	-3.0110	4.57E6	1.98
DC	8.2760		
<b>Total</b>	<b>55.508</b>	<b>3.56E7</b>	<b>87.72</b>

Two to Three orders of magnitude lower than a strip-line kicker

## Discussion in WG4 session 1 & 2

- **What is the present status for high current ERL of each components?**
  - Cavity design & test results are OK to meet the more than 100mA operation
    - Need to be cared not to contaminate the field emission source in storing assembly.
  - HOM damper/coupler limit at present ?
    - HOM damper works well with CW 40mA at Cornell? Waveguide is also candidate.
  - How much power can be fed by one FPC. (> CW 100mA)
    - Cornell 50kW/coupler, KEK 40kW/coupler 1.3GHz, BNL 500kW/coupler 700MHz
- **What is the optimum & stable CW operation field with High-Q for a long time ?**
  - 15-20MV/m and  $Q_0=(1-3)*10^{10}$  desired (LCLS-II:  $2.7*10^{10}@16\text{MV/m}$  with N2-dop)
    - Push high-Q study more.
  - How long high-Q will be kept and how much degradation ratio and stoped?
    - CEBAF 1-2%/year, SNS also meet the degradation ??/year.
    - KEK met degradation during beam operation. But it seems to be stopped now.
  - How to stop the field emission (Dark) current from cavity in operation ?
    - By using collimator and Q-magnet between the cryomodules.
    - We need careful simulation and discuss with beam dynamics Group (WG2).
  - What is the performance translation from the V.T to H.T ?
    - V.T to cryomodule with  $Q_0=2*10^{10}$  (Cornell), EURO-XFEL 20% degradation)



# ERL2015 WG4:

## WG3-WG4 joint session

Jun. 10	15:55 – 17:35	Lecture Hall 2
---------	---------------	----------------

<u>15:55-16:20</u>	<u>Performance of the digital LLRF systems for cERL at KEK</u>	<u>Feng Qiu</u>	<u>KEK</u>
<u>16:20-16:45</u>	<u>Resonance Control for Narrow-Bandwidth, Superconducting Accelerator Applications</u>	<u>J. P. Holzbauer</u>	<u>FNAL</u>
<u>16:45-17:10</u>	<u>Using a 1.3GHz 20kW Solid State Amplifier as RF Power Supply for DC-SRF Photo-injector</u>	<u>Fang Wang</u>	<u>Peking University</u>
<u>17:10-17:35</u>	<u>Discussion</u>		

### ERL Instrument and SRF

- LLRF control and its stability performance for ERL
  - RF sources for ERL
  - Tuner performance and control for ERL

[Thanks to the WG3 contribution to discuss above themes](#)

# RF systems in cERL

F.Qiu

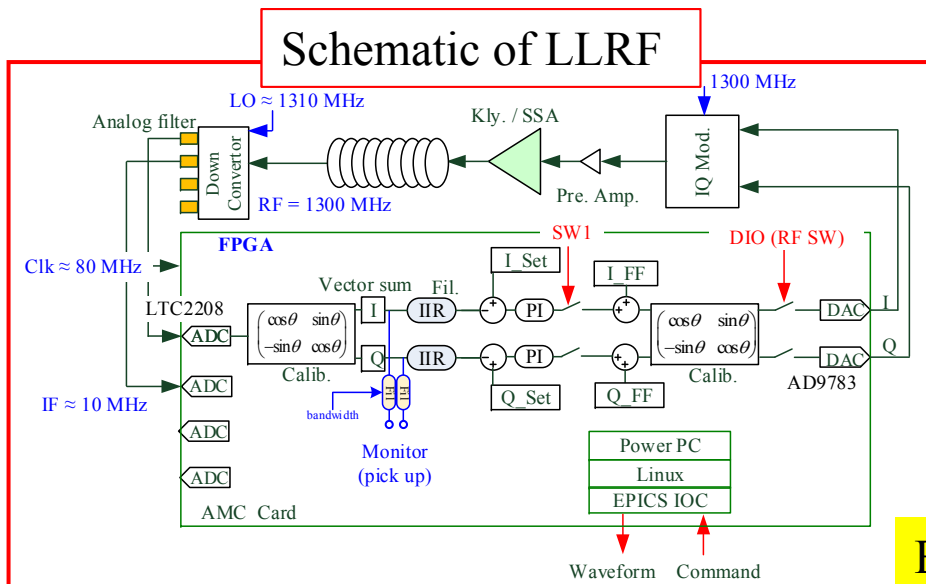
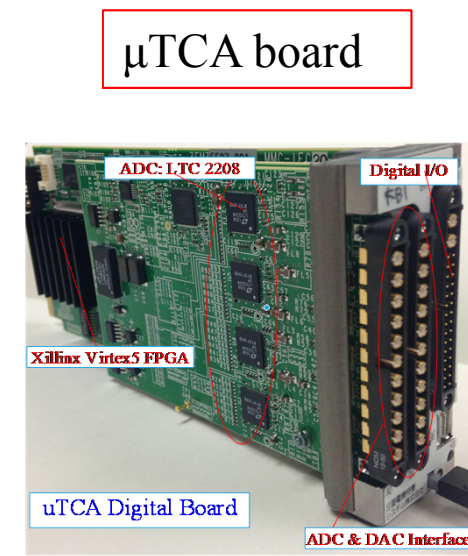
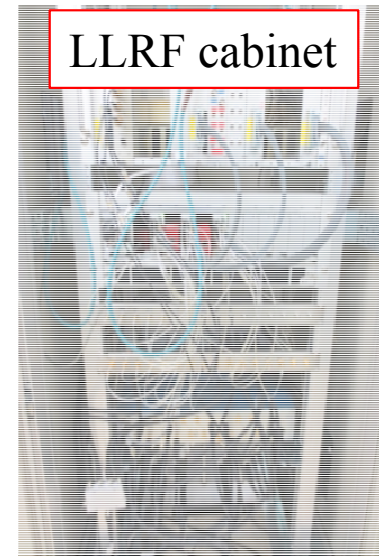
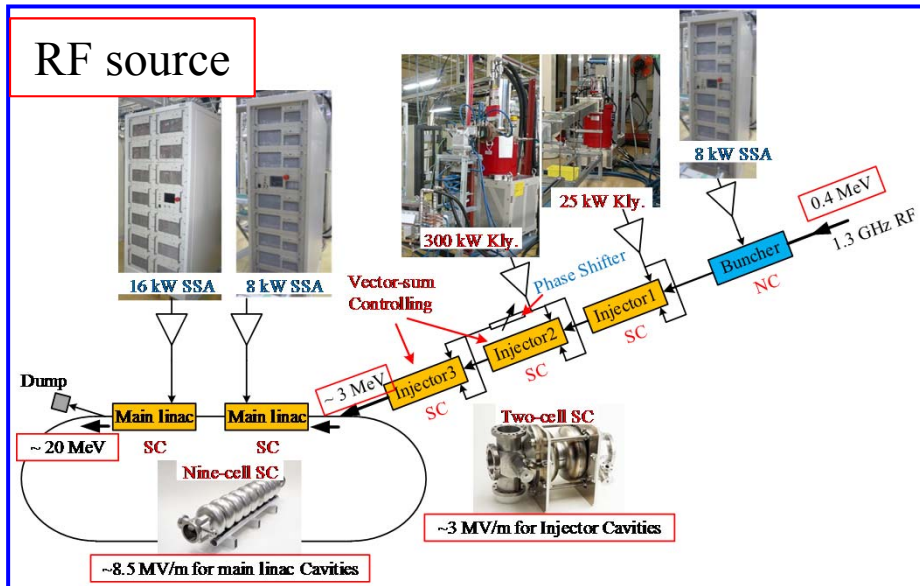

### RF requirement

**0.1 % rms, 0.1 deg. rms for cERL**  
**0.01% rms, 0.01deg.rms for 3GeV-ERL**

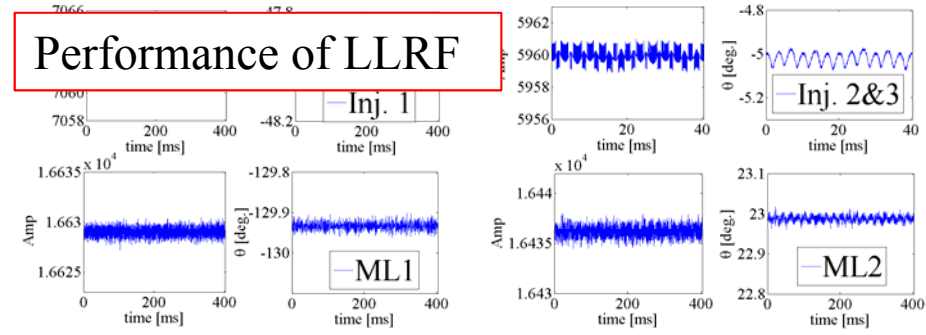

**Beam Momentum jitter is 0.006% (in agreement)**

**This LLRF almost satisfied RF requirement of not only cERL but also 3GeV-ERL**

# Adaptive FF approach

F.Qiu

Adaptive FF also works well.

Basic idea of Adaptive FF control (model-based)

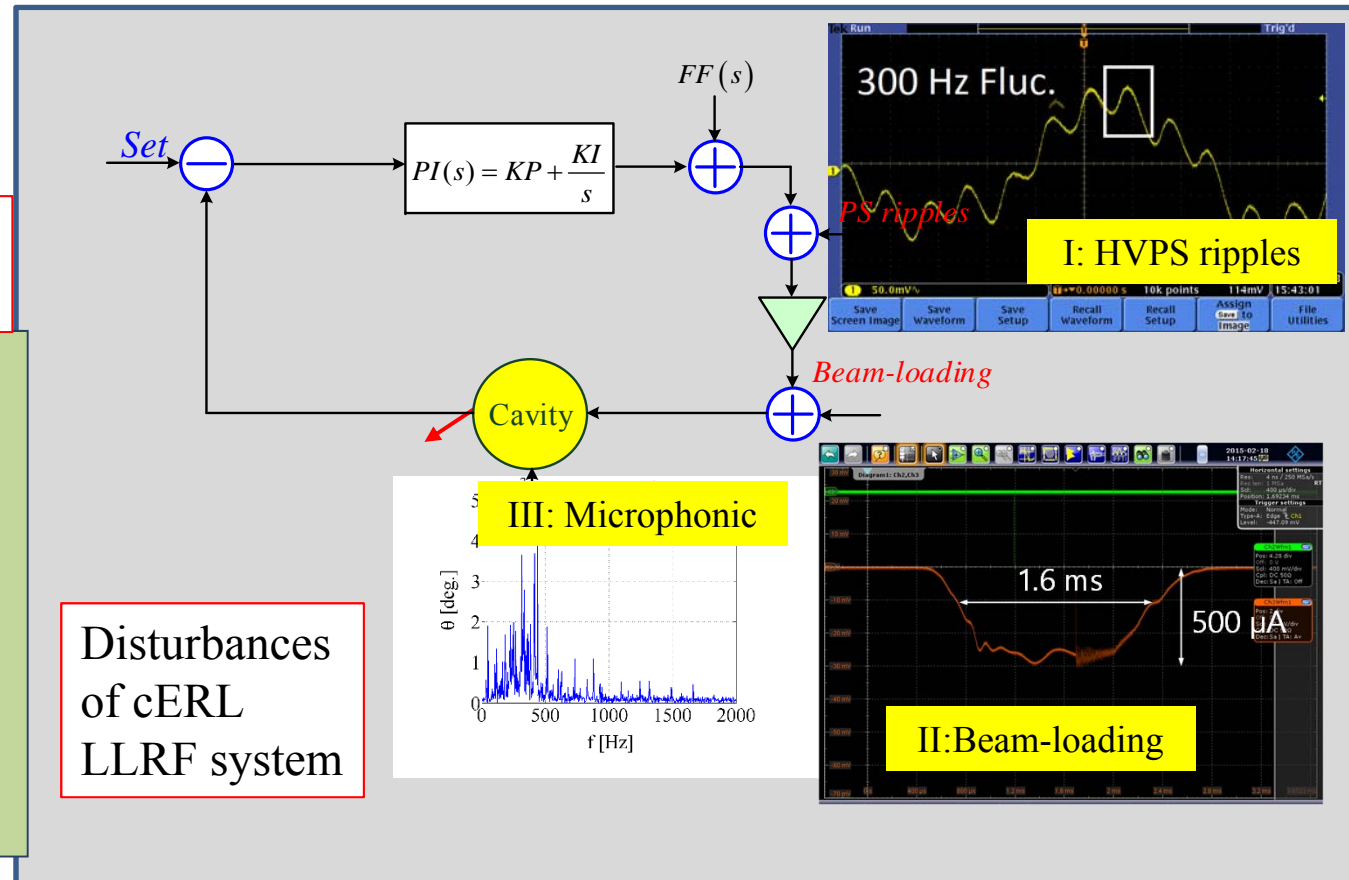
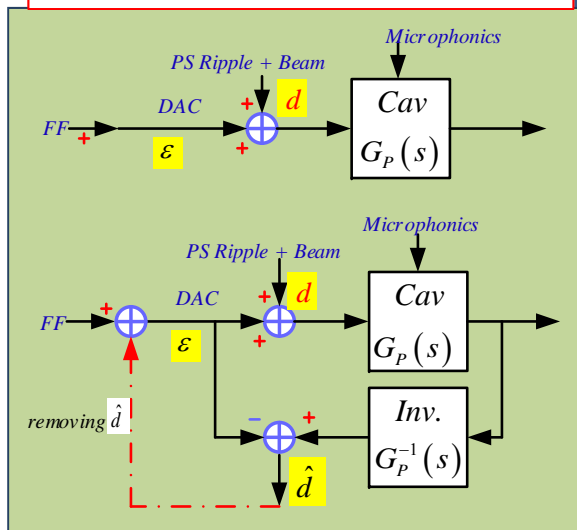

Disturbances of cERL LLRF system

App. I: PS ripples rejection

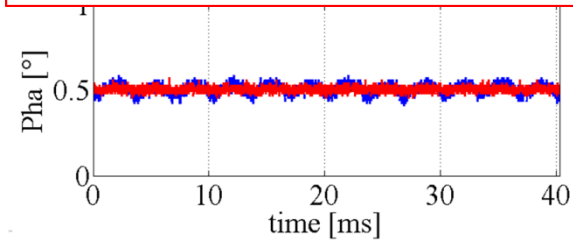

App. II: Beam-loading compensation

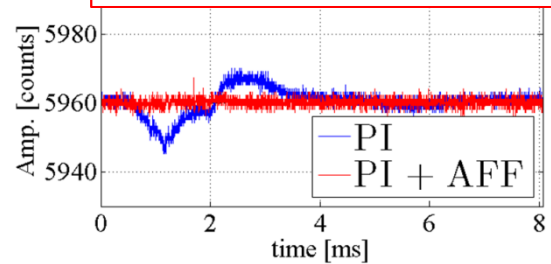

App. III: Microphonics rejection

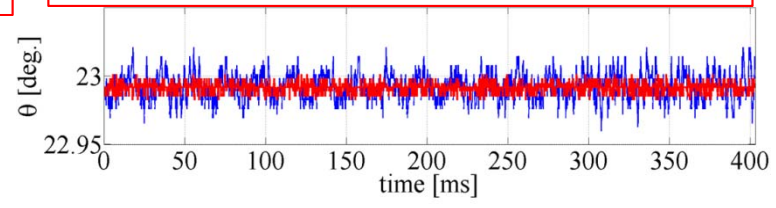

## Best Results at FNAL

- New control system seems to have removed the double-peak seen in the 2011 FNAL data.
- Measurement conditions:
  - Open loop drive
  - 4.3 K
  - 0.25 Hz Bandwidth
  - 5.8 Peak/RMS
  - 325 MHz Single Spoke Resonator
  - 2 hours of data
  - Fast feedback loop
  - Slow feedback loop
  - LFD feedforward
  - 11 mHz RMS detuning
  - 14 MV/m Gradient
  - 1.3 degrees RMS phase
  - 0.02% RMS amplitude

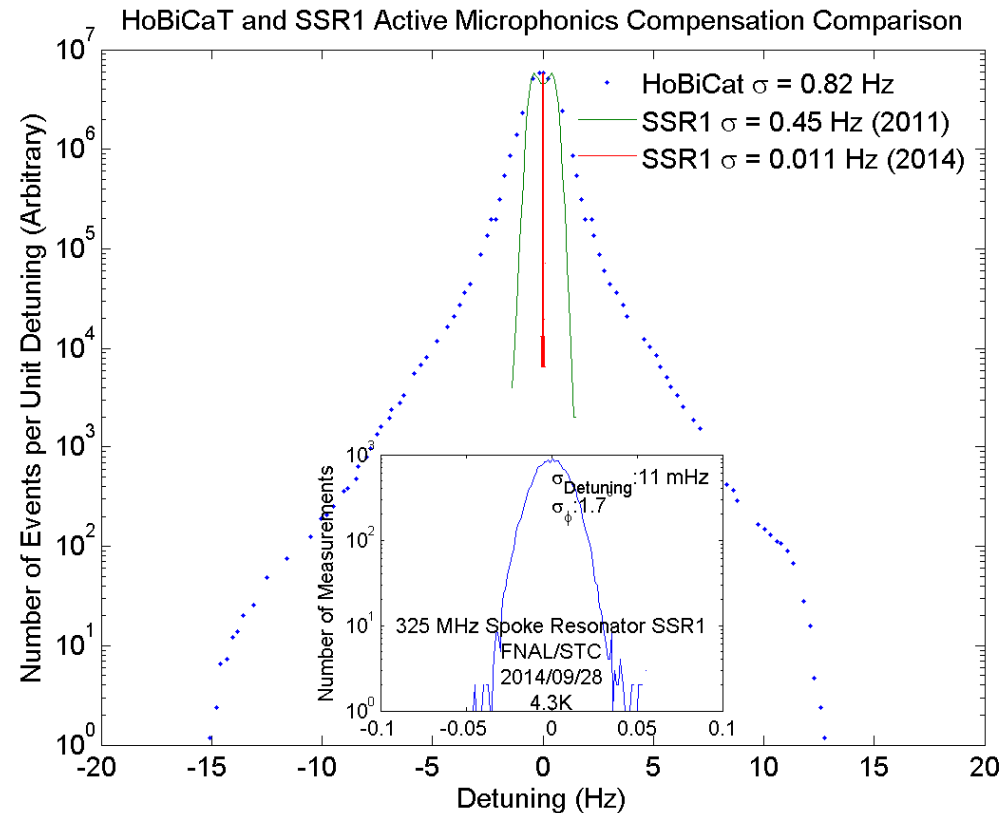

# Conclusions

- Controlling cavity detuning will be critical for successful operation of PIP-II because of narrow cavity bandwidths ( $f_{1/2} \sim 30$  Hz)
  - Narrow bandwidths would be challenging even with CW operation alone
  - Pulsed mode operation brings significant additional complications
- All possible passive measures must be exploited but active control will still be required
  - Will require both best LFD and best microphonics compensation achieved to date operating reliably over many cavities and many years
    - Early test results provide reason for **CAUTIOUS** optimism
  - There are no existing examples of large machines that require active control of detuning during routine operation
- Cross-disciplinary challenges may be more difficult to solve than technical challenges (which are still considerable)
  - Minimizing cavity detuning requires optimization of entire machine
  - Will require active coordination across divisions and across disciplines



## Applications 1.3GHz CW Amplifiers

Facility	Type	Power
<b><i>DC-SRF Injector at PKU</i></b>	<b>SSA</b>	<b><i>1×20 kW from BBEF</i></b>
ELBE at Rossendorf	SSA	4×20 kW from Brucker
bERLinpro cavity	SSA	3×15 kW (?)
Cornell ERL injector	Klystron	5×120 kW from e2v
Cornell ERL injector	IOT	1×16 kW from Thales
ALICE at Daresbury Lab	IOT	5 IOTs from three manufactories (e2v 16kW, CPI 30kW, Thales 16kW)



- A 1.3 GHz 20 kW CW solid state amplifier is developed under the cooperation between BBEF (Beijing) and Peking University. It is the first CW solid state amplifier more than 10kW in China.
- Test results shows the technical specifications are mostly achieved.
  - RF average power 20 kW
  - 3dB bandwidth  $> \pm 30$  MHz
  - Gain  $> 85$  dB
  - RF phase shift vs. output  $9.5^\circ$
  - Gain change vs. output 1.6 dB
  - 2nd harmonic -69 dB
  - 3th harmonic -56 dB
  - Temperature gradient of power  $\pm 0.8\%$  /  $^\circ\text{C}$
  - Delay 75ns
  - Efficiency 34% at 20 kW output, 20% at 9.5 kW output
- It has been applied to the experiments of the DC-SRF photo-injector at Peking University since 2012 and works stably.
  - Amplitude Instability  $< 0.1\%$
  - Phase Instability  $< 0.1^\circ$

## Discussion in WG3-WG4 joint session

- LLRF satisfy the our requirements ?
  - LLRF works well. Encouraging results.
- Strategy to reach the high current beam  $> 100\text{mA}$ 
  - We need to consider the process to commission the ERL.
  - We need to start the beam tuning with nominal bunch charge.
- Even in an CW ERL, transients must be considered.
  - Failure modes (not only stop the injector but also eject beam)
  - Clearing gap
  - ...
- Hit worse HOM's of one cavity
  - Detuning
  - De-Qing
  - Feedback ?



# Summary

- A positive and steady advance is seen at every laboratories.
  - Accumulation of operation experience, improvement of existing machine, construction and new proposal of ERL.
- Progress of the development of components:
  - Recent high-Q R&D is a great work especially with N<sub>2</sub> doping (FNAL Cornell) . This lead us to reach more higher gradient CW operation of ERL
  - Cavity performance including cryomodule test has reached to the ERL level and meet requirements. (Cornell)
  - We met the degradation with field emission (FE) during the long beam operation (KEK).
  - HOM damper was performed with real high current beam with CW 40mA (Cornell).
  - Calculated BBU current > 100 mA with BBU suppressed cavity design (BNL, Cornell, KEK, HZB) and new design with slotted type was suggested. (IHEP)
  - Cavity fabrication technique catch up with the mass production phase now. (MHI)
  - LLRF with tuner control of stable power source reach very high stability. ( $\Delta A/A < 0.01\%$  ,  $\Delta\theta < 0.01$  deg) (KEK, FNAL, PKU)
  - New SRF guns start in operation (HZDR,BNL). Dark current is severe problem at present.
- As the next;
  - All key components are in the level of practical use expect for HOM damper (>100mA).
  - However we know the difficulty of SCRF operation with high gradient in cw mode, because of FE and other disturbances.
  - Construction of new ERLs is underway (ex. HZB,Cornell/BNL,CERN). We will accumulate the operation experiences so that we can meet for stable operation at the next ERL2017.

# Thank you



# BNL tour (ERL test facility) (1)

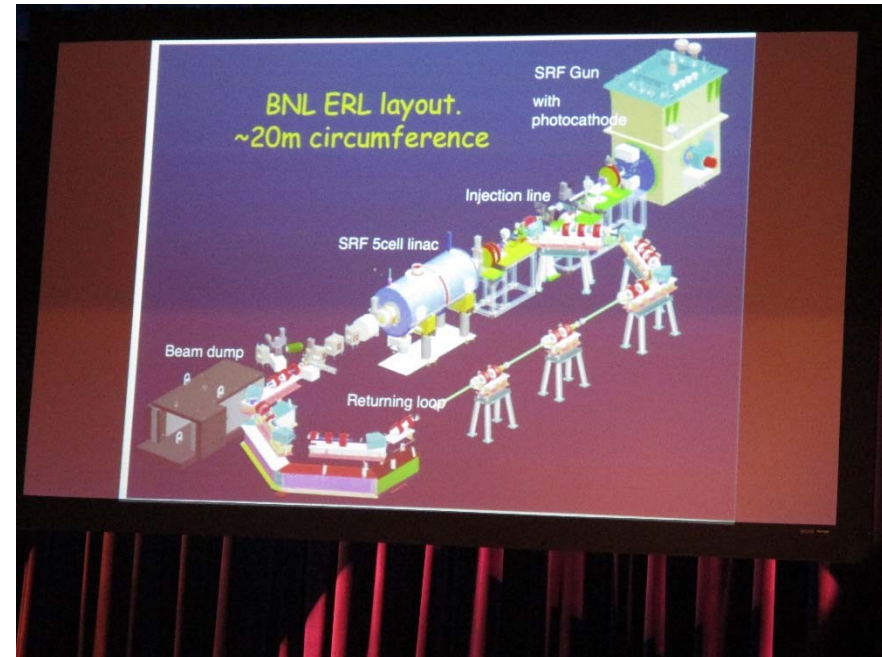

## BNL tour (ERL test facility) (2)

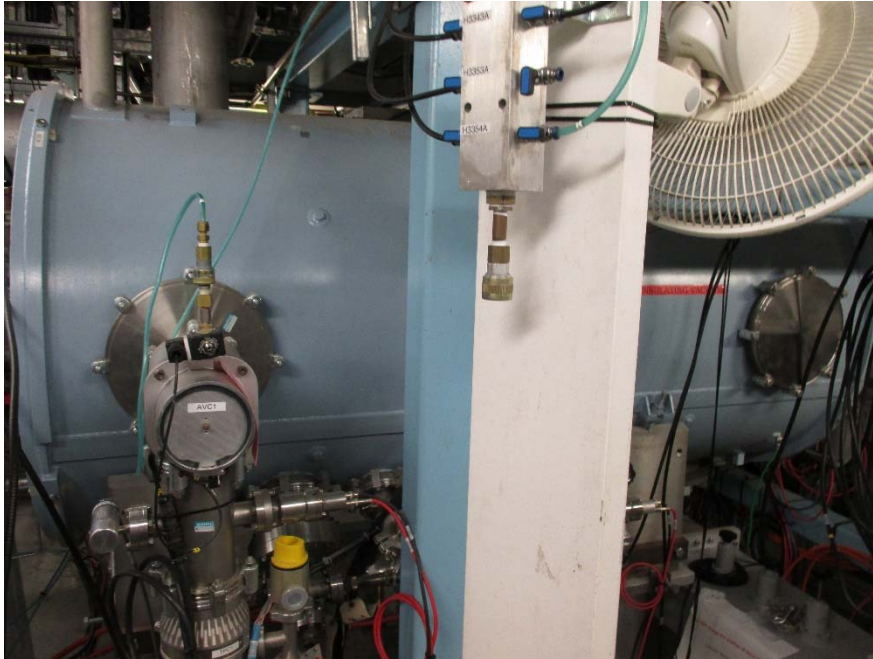

一応、loopが全部できていた。主にinjector部がメインでcomissioning

ここで縦測定を行っている。

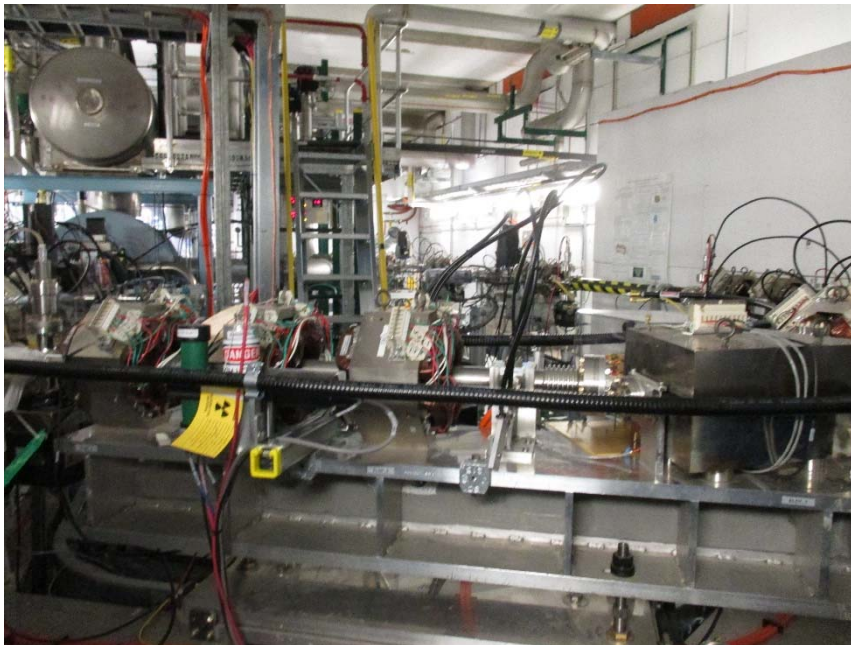

# NSLS-II (1)

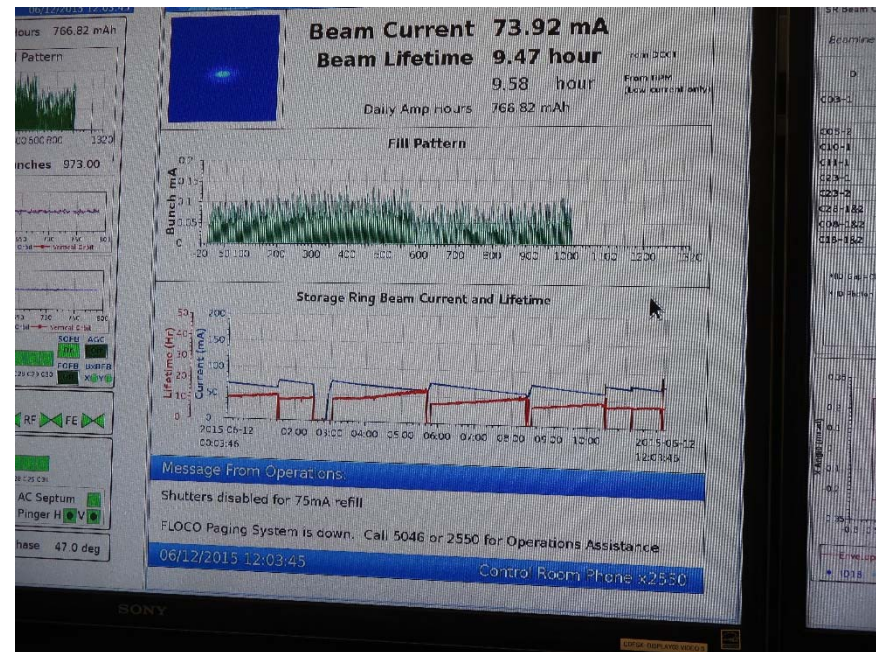

## NSLS-II (2)

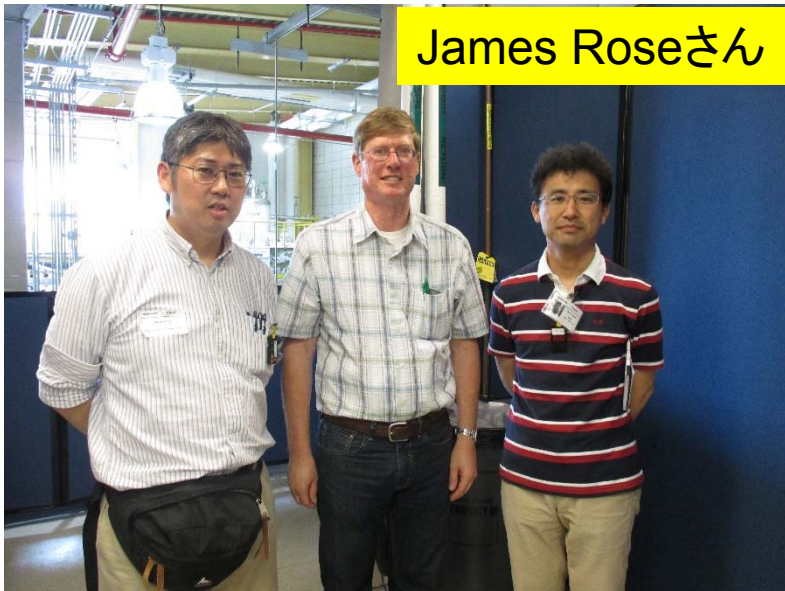

James Roseさん

500MHz (CESR type)が1つすでにNSLS-IIIに installされている。写真はもう一つの500MHzの空洞(AES)が横スタンドに置かれている状態。(150kWまでがmax>windowの問題)

黄色の空洞(サブマリンをimage(^-^))はあらたに1.5GHzの3倍波の超伝導空洞。これらは自分らで作ってassemblyも自分らのclean roomで組んでいる。今後横測定をする予定。