



Question to be addressed (Tuesday)



CHESS & LEPP

- (1) Project overviews
 - (a) JLAB
 - (b) Cornell
 - (c) Daresbury
 - (d) KEK / JAEA
- (2) Are there optimal schemes to minimize bunch length and energy spread?
- (3) What is the optimal injector-to-linac merger design for ERLs?
- (4) What should start to end simulations include?
- (5) What are beam abort strategies and beam loss tolerances?
- (6) What are diagnostic needs specific to x-ray ERLs?

JLab FEL Upgrade

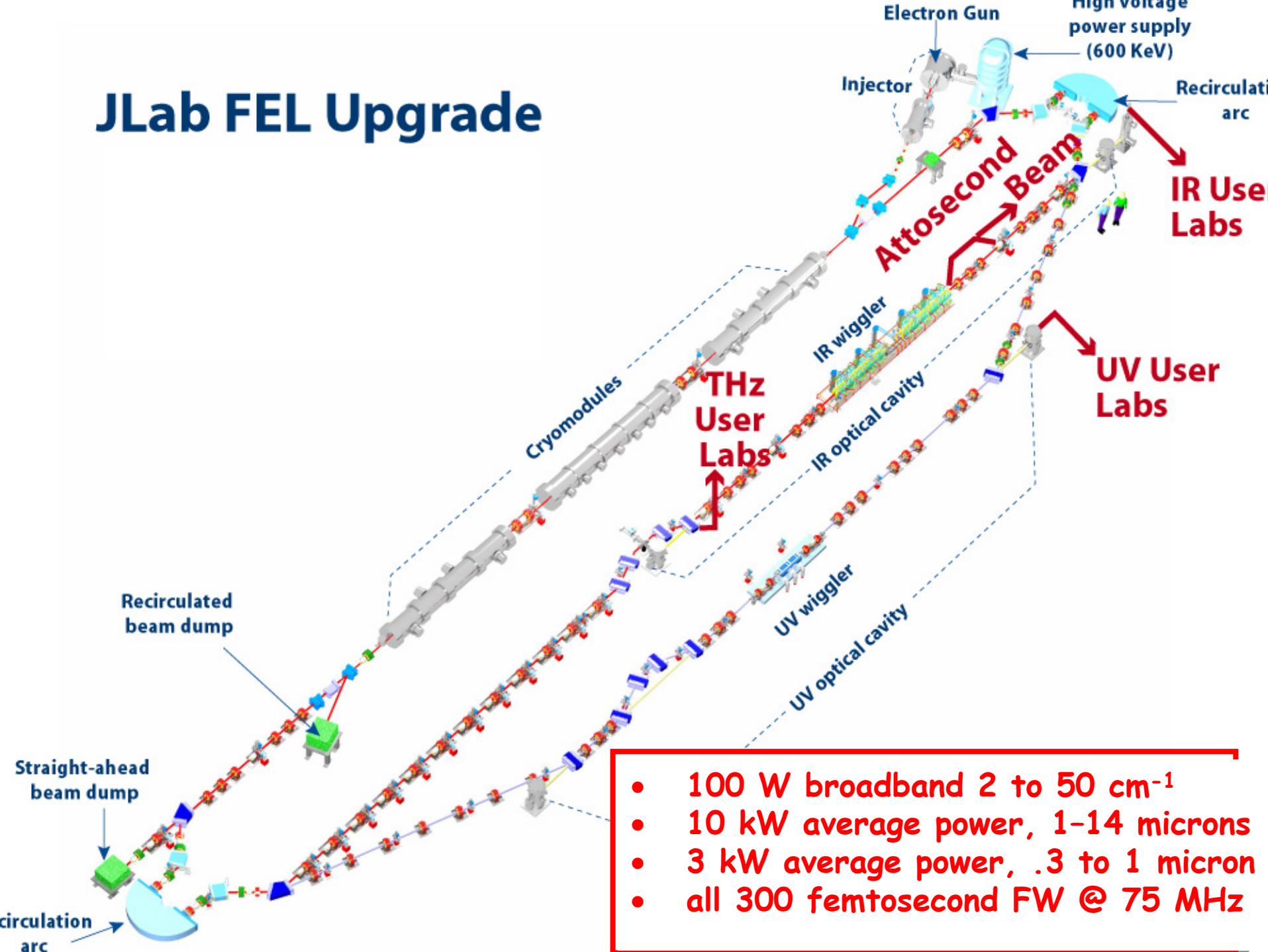

- 100 W broadband 2 to 50 cm^{-1}
- 10 kW average power, 1-14 microns
- 3 kW average power, .3 to 1 micron
- all 300 femtosecond FW @ 75 MHz

Light Source Landscape

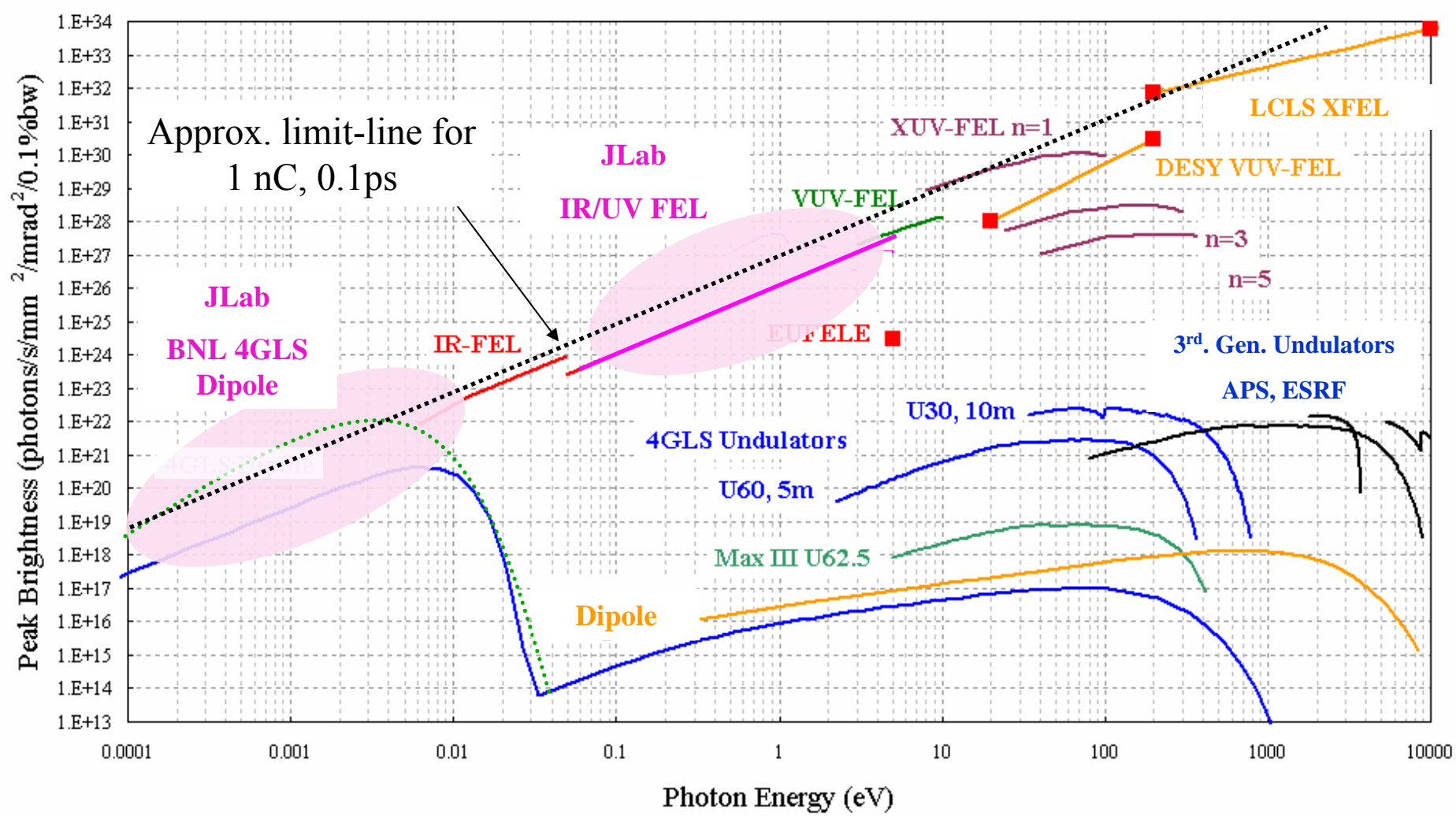

All data is approximate for illustrative purposes

Wendy Flavell Manchester University UK



Thomas Jefferson National Accelerator Facility

Operated by the Southeastern Universities Research Association for the U.S. Dept. Of Energy



Harmonic Radiation while lasing

Tuning movie

Wiggler
gap



High
Reflector

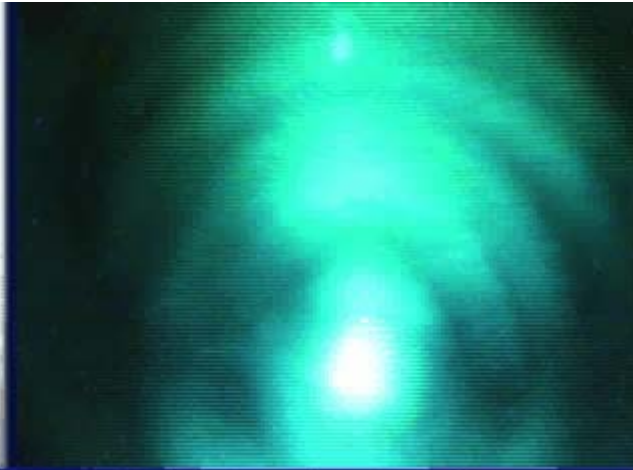

Hole
Outcoupler



Beam in
control
room



ERL Layout

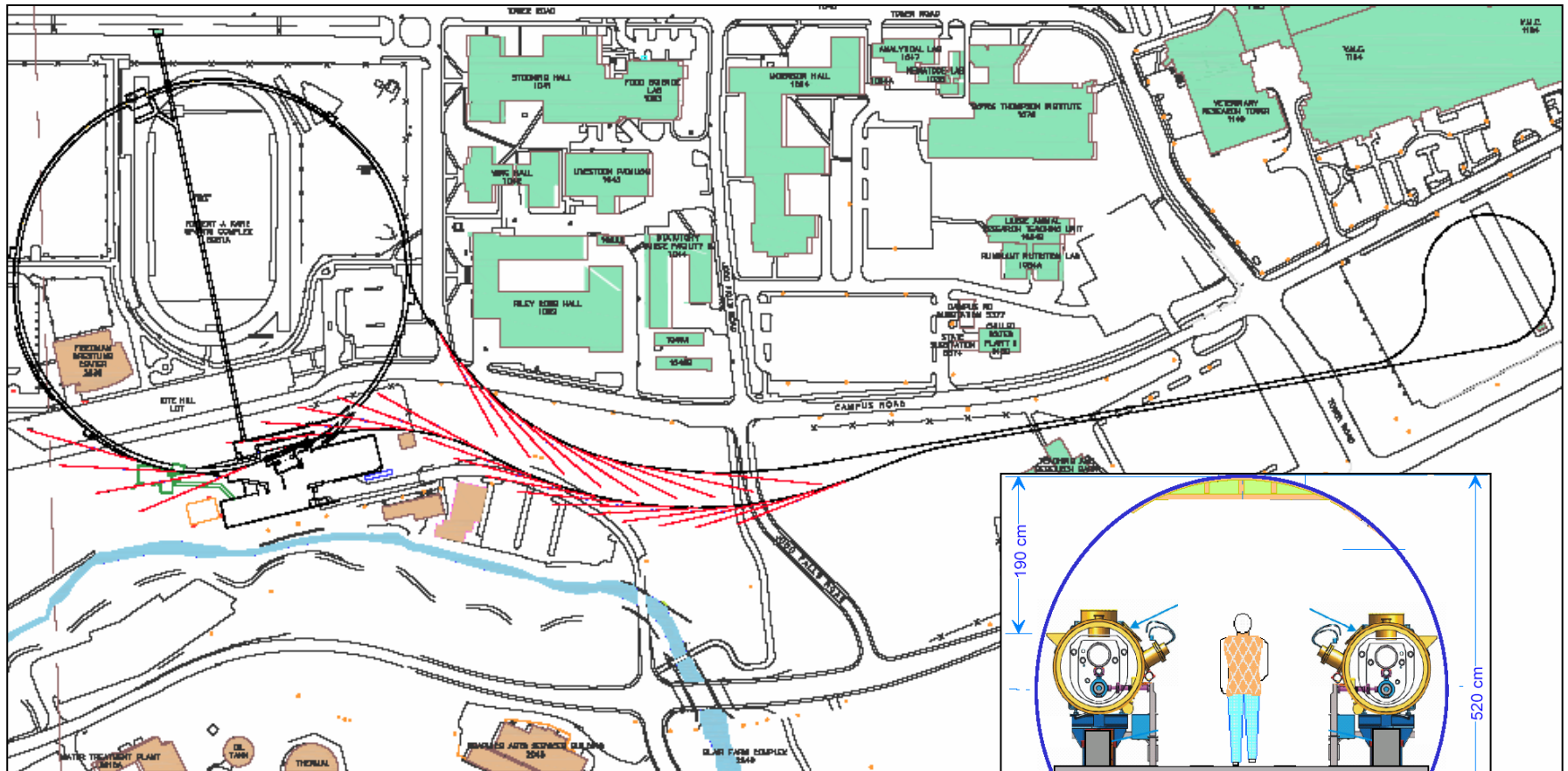

- Injector prototype under construction

-

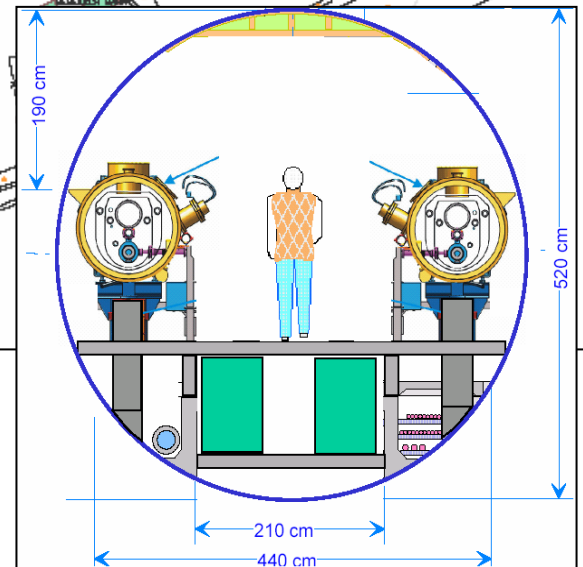

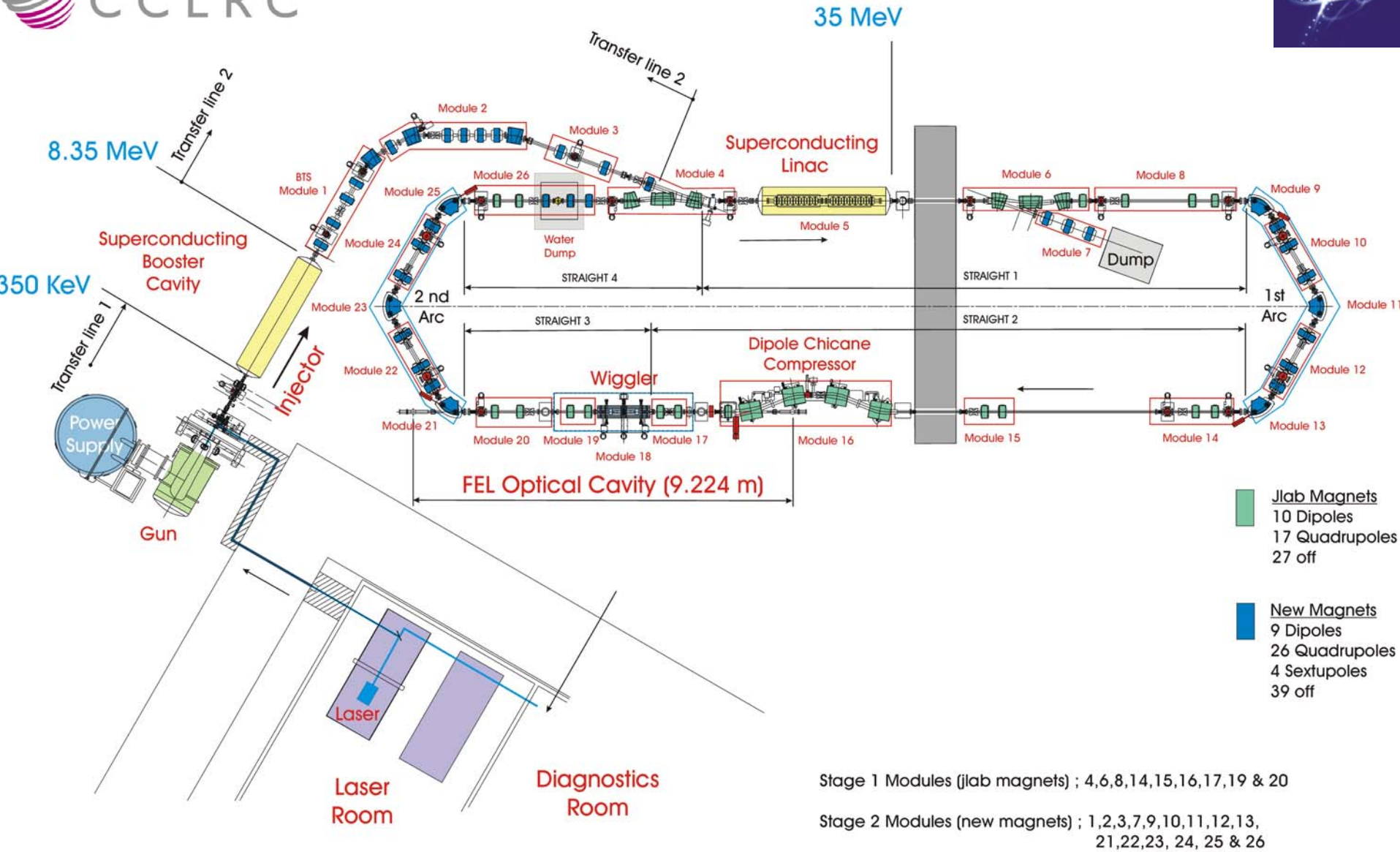

Stage 1 Modules (Jlab magnets) ; 4,6,8,14,15,16,17,19 & 20
 Stage 2 Modules (new magnets) ; 1,2,3,7,9,10,11,12,13, 21,22,23, 24, 25 & 26

Conceptual Layout of 4GLS

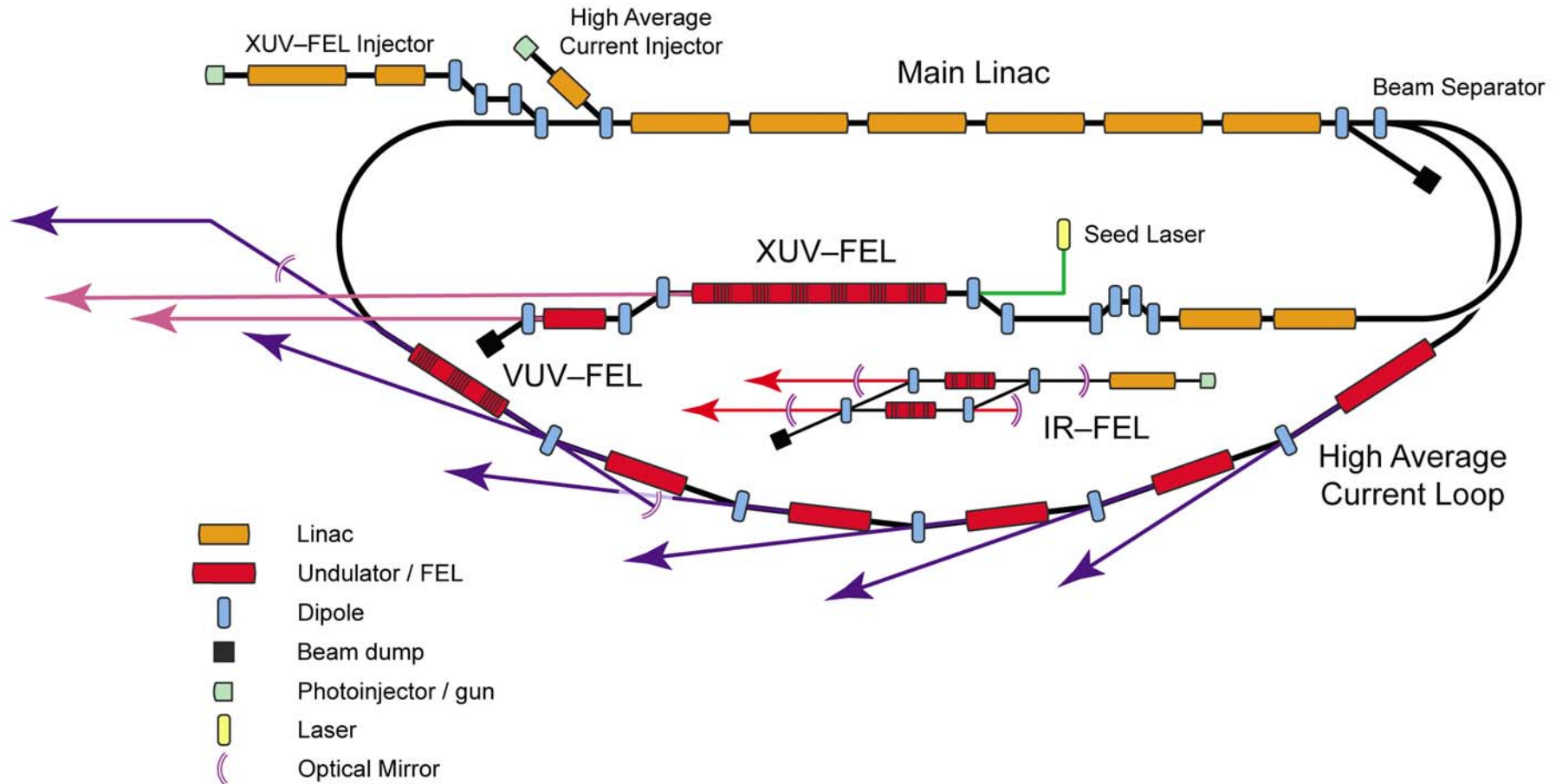

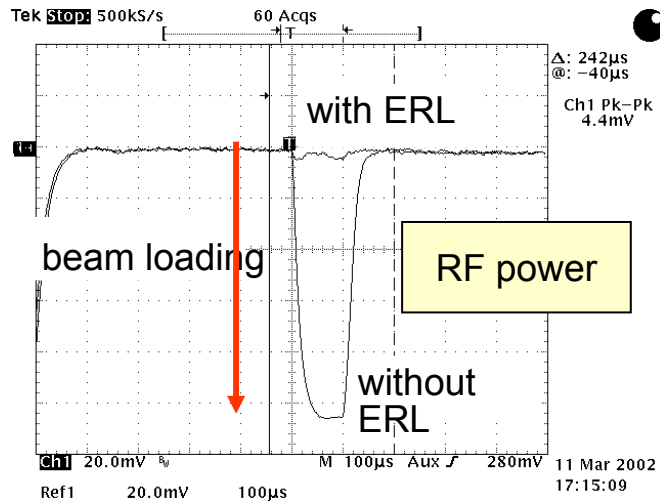
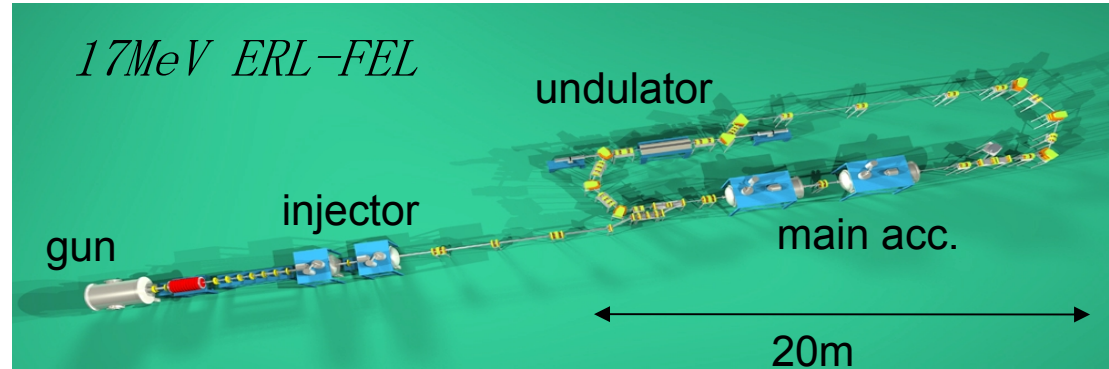

R. Hajima et al., Nucl. Instrum. Meth. (2003)

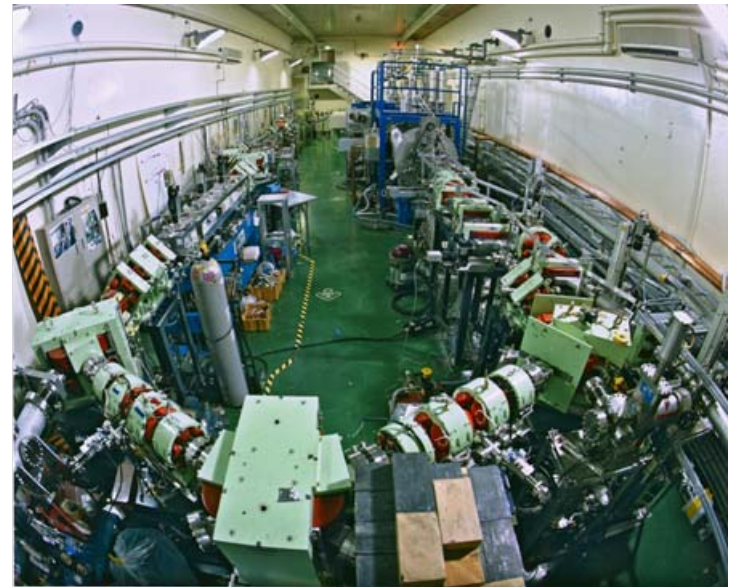

Design, Construction and Operation of the ERL (1999-)

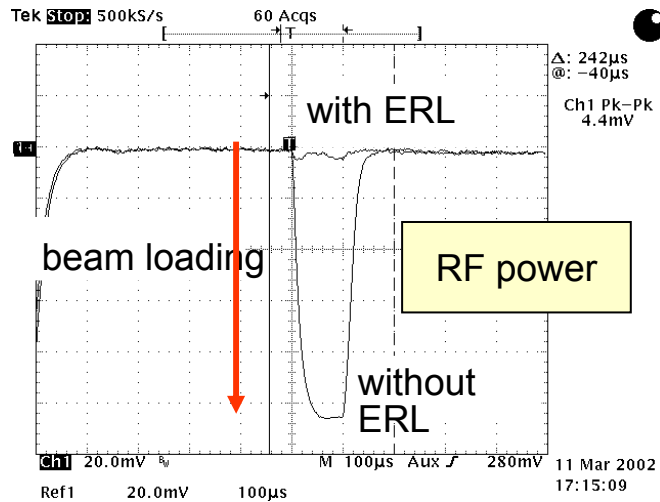
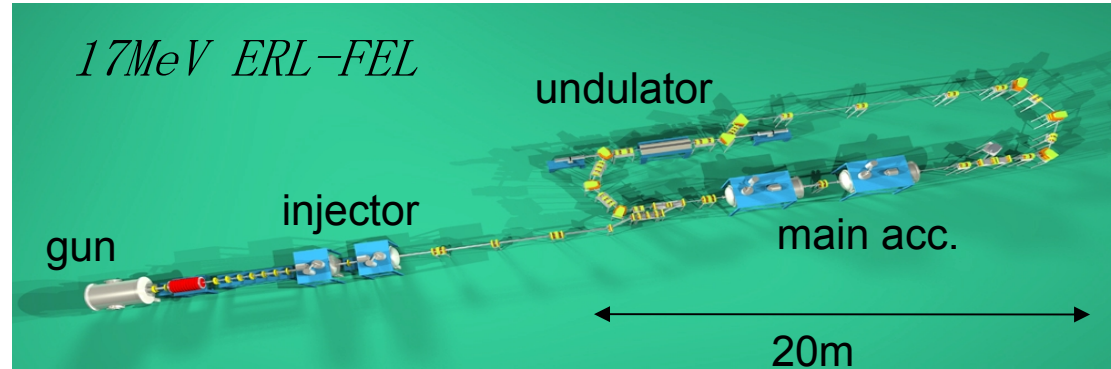

R. Hajima et al., Nucl. Instrum. Meth. (2003)

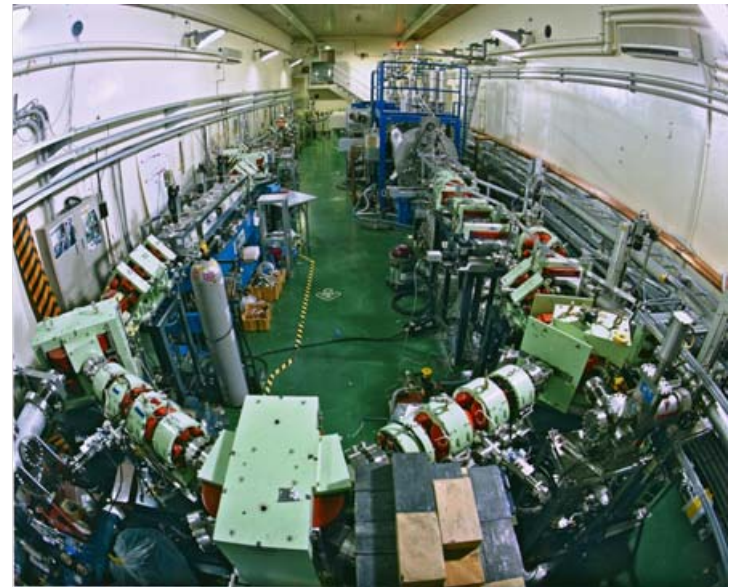

Design, Construction and Operation of the ERL (1999-)

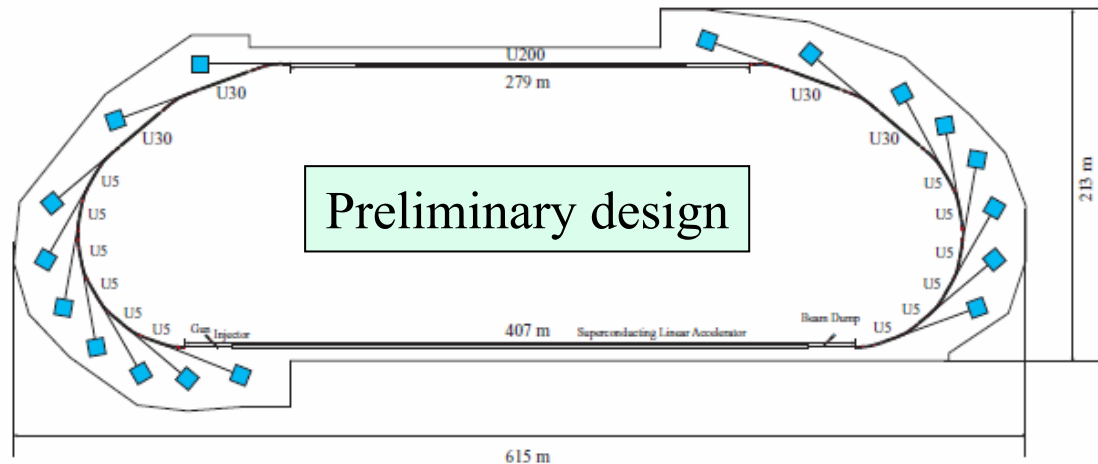

Beam energy	5 GeV
Average current	100 mA
Normalized emittance	0.1 – 1 mm·mrad
Average brilliance (@ 0.1 nm) from ID's	$10^{21} - 10^{23}$ ph/s/0.1%/mm ² /mrad ²
Average flux	$> 10^{16}$ ph/s/0.1%
Spectral range	30 eV – 30 keV
Minimum bunch length	< 100 fs
Number of ID's	20 - 30

Questions to Keep In Mind

- Method of Compression
 - Single Stage (JLab, ERLP)
 - Stepped/2-Stage (FLASH, XFEL, LCLS etc.)
 - Progressive/Modular (4GLS)
 - Large Dispersion/Split Linac Approach (Cornell)
 - Velocity Bunching (JAERI)
- Sextupoles or 3rd-Harmonic for Linearisation?
 - Higher-Order Terms
- Problems in Particular Machines
 - Combined Beams (4GLS)
 - Topology (Cornell)



Split Linac Bunch Flattening



CHESS & LEPP

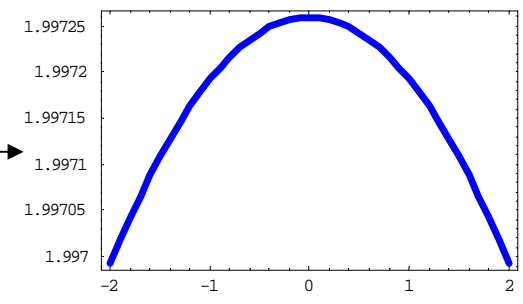
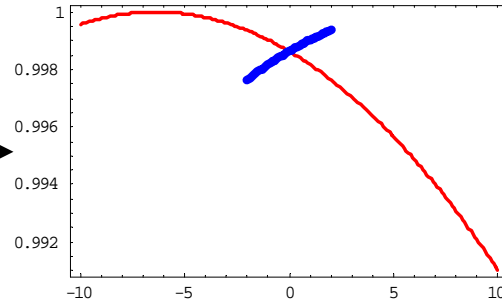
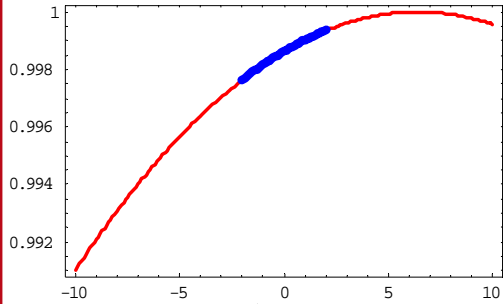

Nonlinear time of flight

2nd order time of flight

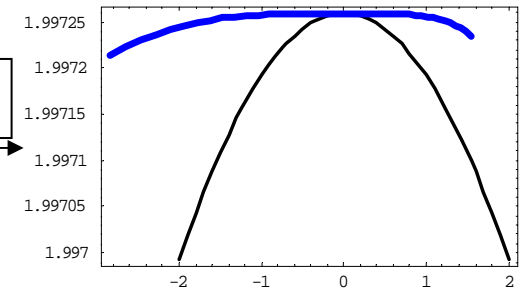
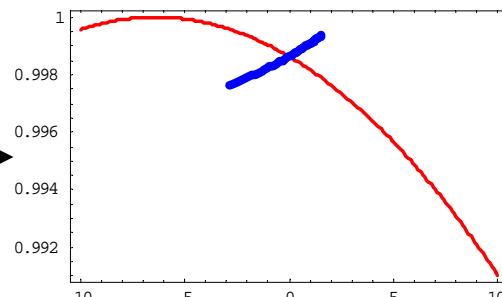
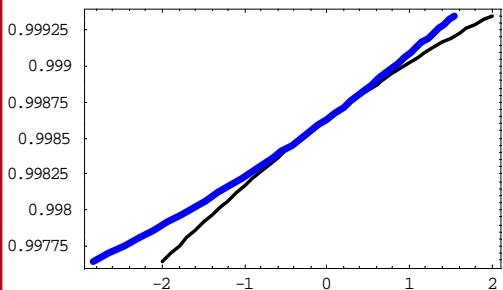

4th order time of flight

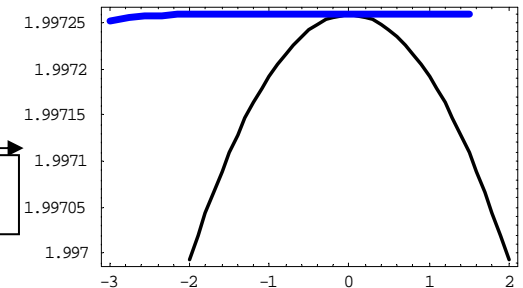

care of emittance dilution in an ERL injector and merger

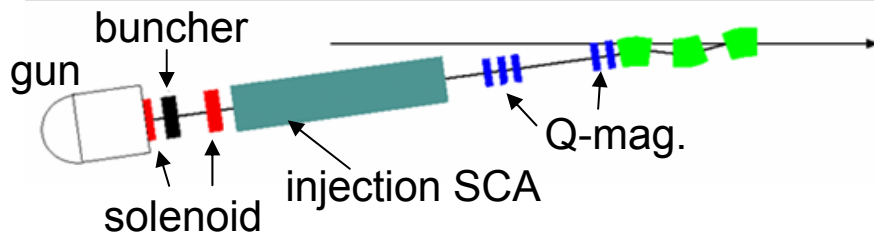

short-term goals

high-flux = 77pC, 1mm-mrad

high-coh = 7.7pC, 0.1mm-mrad

ultrafast = 1nC, 5-10mm-mrad

emittance growth source	location	how to deal with
transverse space charge	whole the path	emittance compensation by solenoid and Q magnets with avoiding "over bunching"
longitudinal space charge	inside the merger	envelope matching to bunch slice displacement induced by LSCF
time-dependent RF	buncher, 1 st SCA	controlling σ_r , σ_z by solenoid, buncher

We cannot eliminate all the emittance dilution simultaneously.

However, numerical simulations give a reasonable design for the emittance requirement.

helpful design tips so far we have:

+ changing position and strength of focusing magnets = minimum " $\epsilon_{TSCF} + \epsilon_{RF}$ ",

+ a weak focusing merger shows better emittance compensation.

2step staircase (JAERI type) is not suitable for small emittance due to strong focusing

What should Start to End Simulations for Light Source ERLs be sure to include?

- energy spread and emittance are very crucial for FEL operation and have to be carefully observed therefore**
- most relevant (single bunch) effects with the potential to deteriorate bunch quality: space charge and CSR fields, cavity wakes, resistive wall and geometric wakes**
- simulation codes for each of these effects are available but no code that includes all**
- for Start-to-End simulations output-input conversion has to be done: best and most easily the 6D macro particle phase space is used**
- with parametrizations: correlations between phase space dimensions may not be neglected**

What are realistic beam abort strategies and beam loss tolerances for light source ERLs?

Standard beam trip detection and abort seems to be acceptable for ERLs. The energy in the beam appears to be not significantly different from 3rd generation light sources. Just don't put too much energy in sensitive points.

Beam loss tolerances and the causes of halo are less well characterized and various labs are presently taking different approaches. Work on minimizing sources of such halo and developing methodologies for dealing with it is desirable.

Halo sources

- Beam induced (not usually significant)
- Field emission from gun and srf cavities
- Scattered light in photoinjector (both temporal and transverse halo)

Loss impacts:

- Wiggler life
- Vacuum and vacuum failures
- Background radiation
- Radiation on X-ray beamline
-

Injector Diagnostics < 10 MeV

- Initial measurement of gun performance should be done in *test stand* where additional diagnostics can be used
- Shielded Beam Viewers
 - <10MeV these should be phosphor coated
 - YAG or ceramic OK but these bloom more than the thin coat of phosphor
- Multiple BPMs, Shorted striplines for larger signal than button and low impedance
- Multislit or pepper pot for H/V emittance
- Beam Current Monitor (BCM)
 - Knowing charge is crucial to setup
 - Transformer or cavity, advantage with cavity is one can use log-amp on output and this makes tuning the drive laser E/O cells easy, and it is only ~\$5k
- Streak camera for longitudinal measurements

Linac Diagnostics

- All devices should be *shielded* to minimize beamline shunt impedance
 - Including bellows and ion pump drops
- BPMs, both single pass and multi-pass
- OTR beam viewers
 - In linac where there are two beams they should have 5mm holes to pass accelerating beam
- Interferometer for bunch length
 - Source can be from THz and/or OTR
- Transverse kicker cavity for longitudinal measurements
 - Needed where bunches are beyond streak camera resolution
- Synchrotron light ports at every bend
- Halo monitors
 - These can be phosphor coated beam viewers with or without holes or forks



FLS 2006

37th ICFA Advanced Beam Dynamics Workshop on Future Light Sources

Energy Recovery Linacs (Thursday)

Susan L Smith

ASTeC, Daresbury Laboratory

Vacuum and Aperture Needs for ERL-LS

conservative design (10^{-10} loss / turn) = similar to storage rings

- install distributed pumps in bending (and Q) chambers
- keep full-aperture > 5mm and vacuum $\sim 10^{-7}$ Pa everywhere

progressive design (10^{-7} loss / turn at controlled locations)

- put scrapers at appropriate locations
- allow beam loss of a few watt at each scraper $\rightarrow 10^{-7}$ loss / turn
- vacuum level of 10^{-4} Pa is enough for 4mm full-aperture
- keep good vacuum at undulators, $\sim 10^{-7}$ Pa, in any case
- pay much attention to ion effects

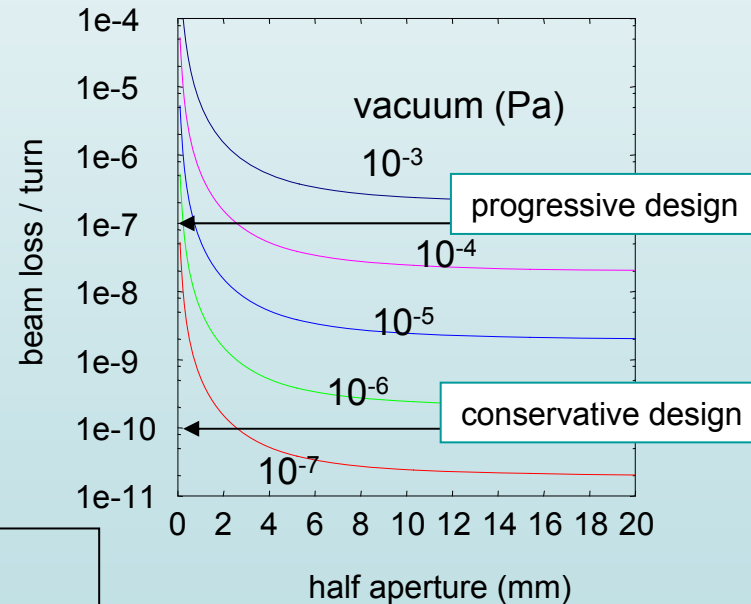

beam loss for 5GeV-ERL

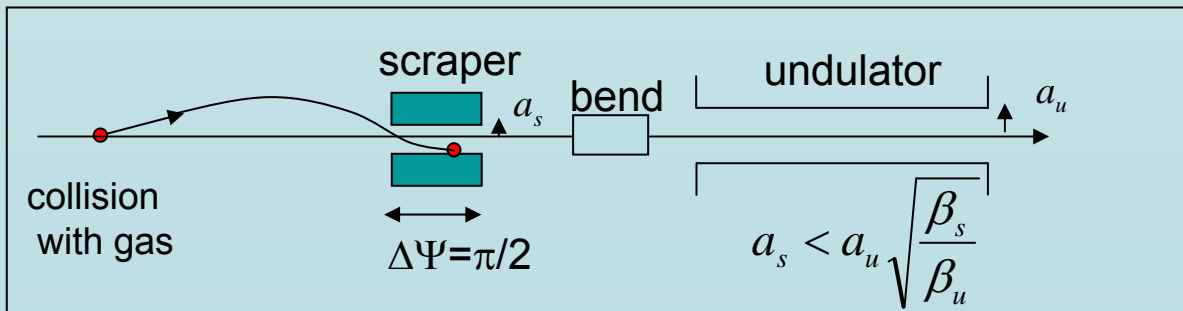

- Recirculation makes life harder, safety margins smaller, but may not be limiting
- A “value engineering” decision?
- Compression and other niceties should be avoided in lower energy recirculation
 - Allow emittance cancellations between superperiods
 - Keeps energy spread reasonable
 - In general, optimize lower energy arc optics for recirculation, not bunch manipulations
- My favorite issues
 - Microwave-like CSR instabilities
 - Cost model

$\Delta f =$ around 3.6 Hz, $Q_L =$ mid 10^8 (Dream?)

Aspects that must be investigated whether high Q_L operation is possible:

- How far can one reduce the microphonic detuning? For around $Q_L = 10^8$ - 10^9 require *peak* detuning between 1 and 10 Hz.
 - Investigate low-microphonic modules
 - Given measured RMS microphonics, what peak levels must we design for?
 - Stabilize the helium system down to the 0.01 mbar levels!
 - Use microphonic compensation. This is in its infancy, but promising.
- What spread in microphonics should one expect
 - Must allow for a safety factor when dimensioning RF system
 - At present, factors of 3 in microphonics are not unreasonable
 - Installed RF power must be greater by factor of 3 + coupler adjustability
- Can the RF field be stabilized down to the 0.01-0.02 deg and 10^{-4} level?
 - Requires a high-gain system (500)
 - Cornell/JLAB measurements demonstrated this can be done at $Q_L = 1.2 \times 10^8$ with a “quiet” module
 - Coupling optimized for $\delta f_{pk} = 6 \sigma_{mic}$

3 Hz peak microphonics?
→ $Q_L < 2E8$

→ Even if $Q_L = 1E8$, some cavities will need to run at $Q_L = 3E7$. RF system must be designed for this

→ $Q_L = 1.2E8$ demonstrated
Even higher values may be possible provided low microphonics and low pickup noise

Aspects that must be investigated whether high Q_L operation is possible:

- How much uncompensated beam current can one expect in 100 mA ERLs?
→ changes in beam loading may prove to limit the Q_L . Even $Q_L = 10^8$ may be tough, but more measurements are needed
→ $Q_L < 1E8?$
 - How important is it to RF process the cavities?
→ $Q_L < 1E8$
 - For light sources this may be a big reliability issue
 - For RF processing require Q_L values around 10^6
 - Coupling ranges of x 100 will be tough to achieve → Maximum Q_L would be 10^8
- **Given present status, Q_L values much above 10^8 do not appear feasible (??). Possibly one will have to stay below this.**



What are the Optimal Parameters for Superconducting Cavities of an ERL Light Source?



- L-Band technology sufficient for proposed sources
- Accelerator gradient $< 20\text{MV/m}$ – determined by CW technology. Cost optimisation with both capital and running costs of equipment pushes gradient down
- Q_0 should be as high as possible $> 10^{10}$
- Operation at 1.8K – provided not limited by R_{BCS}
- Trip levels should be no worse than storage ring source
- HOMs damped to better than $Q = 10^4$, power into either beampipe absorbers or waveguide loads at 80K
- Active control of microphonics

Mike Dykes

What are good beam stabilization strategies and their limits for ERLs?

- Most users will come from storage ring based 3rd generation light sources, which are extremely stable (submicron position, permille beamsizes)
 - Combination of passive source suppression and
 - Active feed-forward, feedback
- ERLs with their smaller beamsizes will be more challenging (need fixed beamsize fraction for stability). They need to incorporate stability in design from beginning.
 - Ground plate/site, temperature, cooling water, girders, magnet mounting, ...
 - Orbit feedback for 'slow' (100 Hz) effects seems well in reach with technology extrapolation (except in linac where two beams are present and out of phase)
 - Fast feedback more similar to multibunch feedbacks in rings, easier in return line configs than straight FELs, but resolution needs improvement
 - Beamsizes stability might involve gun feedback
 - Overall there are additional challenges for ERLs!

Undulator Issues for ERLs

37th ICFA Advanced Beam Dynamics Workshop on Future Light Sources

- Round beam – round vacuum chamber so alternative undulator geometries possible
- Electron losses – need to be ~ 1 in 10^{10} to be equivalent to 3GLS
 - Losses on undulator can be controlled e.g. FLASH
- Short bunches and narrow vessel gaps are bad combination
 - e.g. 4GLS 50fs bunch; resistive wall electron loses ~ 80 keV in 10m long copper vessel with 7mm diameter
- Vessel roughness demanding (0.1 to 1 μm) in all ERLs at narrow gaps (to avoid energy spread growth)
 - These levels are available from industry
- Multi-user facility will have undulator cross talk due to energy loss of electron vs undulator gap
 - Feedforward schemes envisaged
 - Variability of dipole CSR emission needs investigation
- Energy spread and emittance growth effects small
- Electron timing affected by undulator gap change
 - Important for low energy ERLs (long wavelengths)

- **Source issues**
 - Cathode heating
 - Cathode lifetime
 - Laser power on cathode
 - Halo production

- **Injector issues**
 - High power couplers

- **Linac issues**
 - Multi turn ERLs
 - BBU and very large current
 - Beam stabilization (!!!)
 - Electron background calculations
 - Accumulation
 - Halo propagation
 - CW high voltage cavity operation with low trip rate
 - Accelerator protection issues



Participants in the ERL working group

And

Session Experts

Ryoichi Hajima

Joe Bisignano

Jens Knobloch

Christoph Steier

Jim Clarke

Georg Hoffstaetter

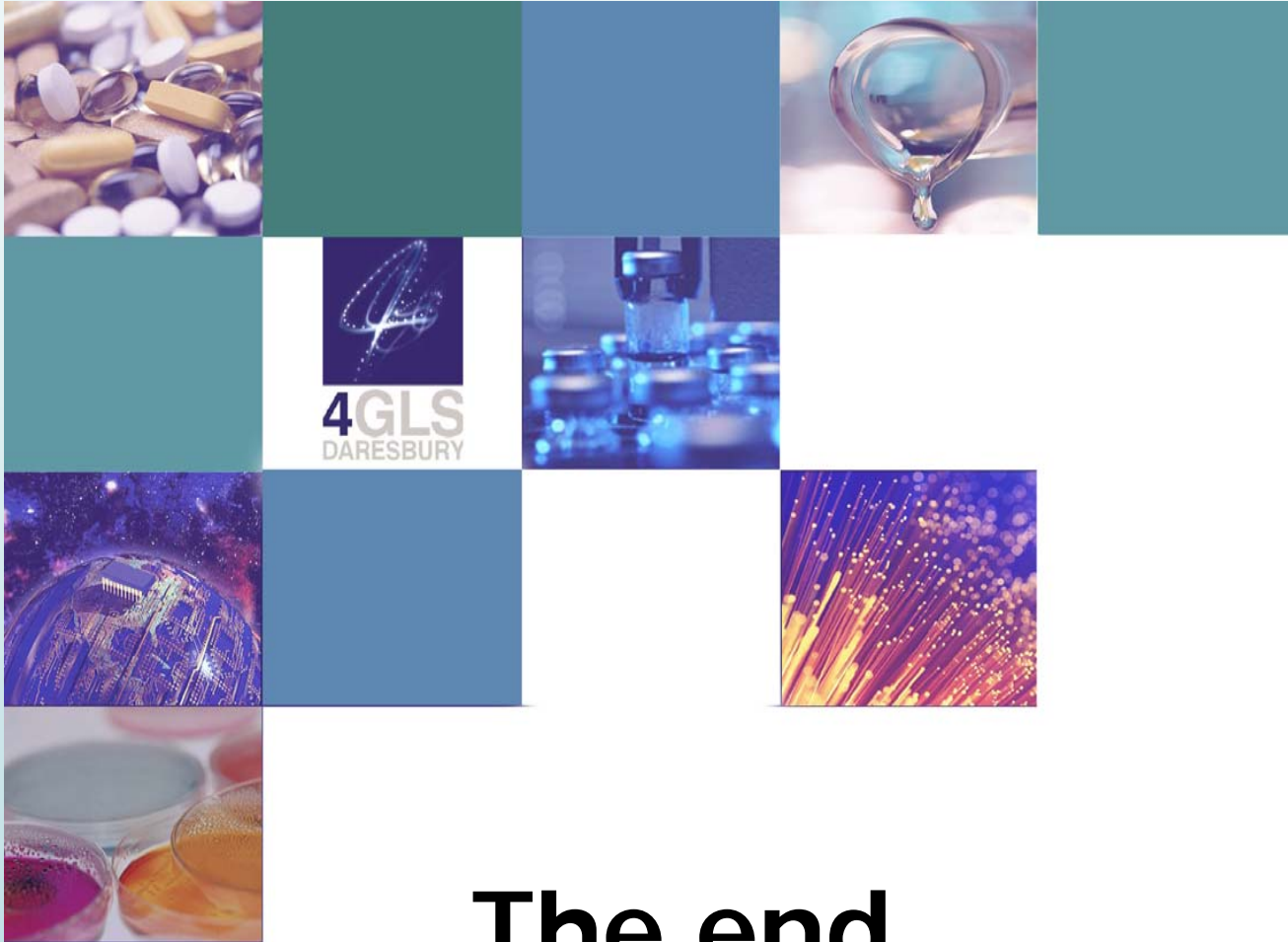

The end