

ERL beam instrumentation

ERL beam instrumentation group

T. Mitsuhashi

S. Hiramatsu

T. Kasuga

T. Obina

M. Tobiyama

T. Naitoh

T. Furukawa

M. Satoh

N. Nakamura

Developments of monitors

Developments of control including fs technology

Beam instrumentation for the ELR

1. Profile measurement

Fluorescence screen

Optical profile monitor by OTR or SR

Wire scanner SEM or Compton scattering

High speed gated camera

2. Position measurement

BPM electronic

BPM SR or OTR

3. Intensity measurement

DCCT, Differential DCCT

Photocathode, Faraday cup

SR or OTR intensity monitor

4. Emittance measurement

Fluorescence screen with slit

Wire scanner

Interferometer SR or OTR

5. Temporal structure

Streak camera SR or OTR

Incoherent intensity interferometer SR or OTR

CSR interferometer CSR

BLM opto-electric

6. Halo

Wire scanner

Coronagraph SR or OTR

7. Beam loss

ERL試験機のレイアウト

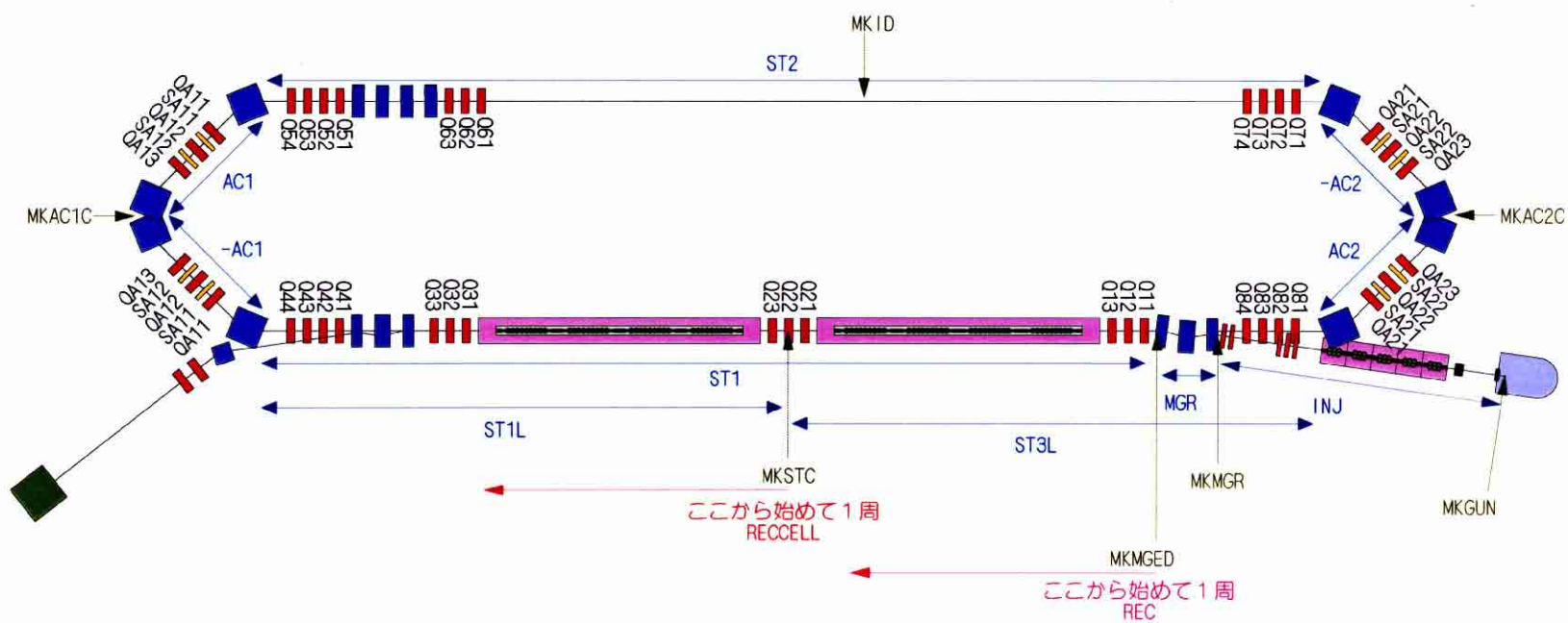

現在提案されている周回部のOptics案（原田）

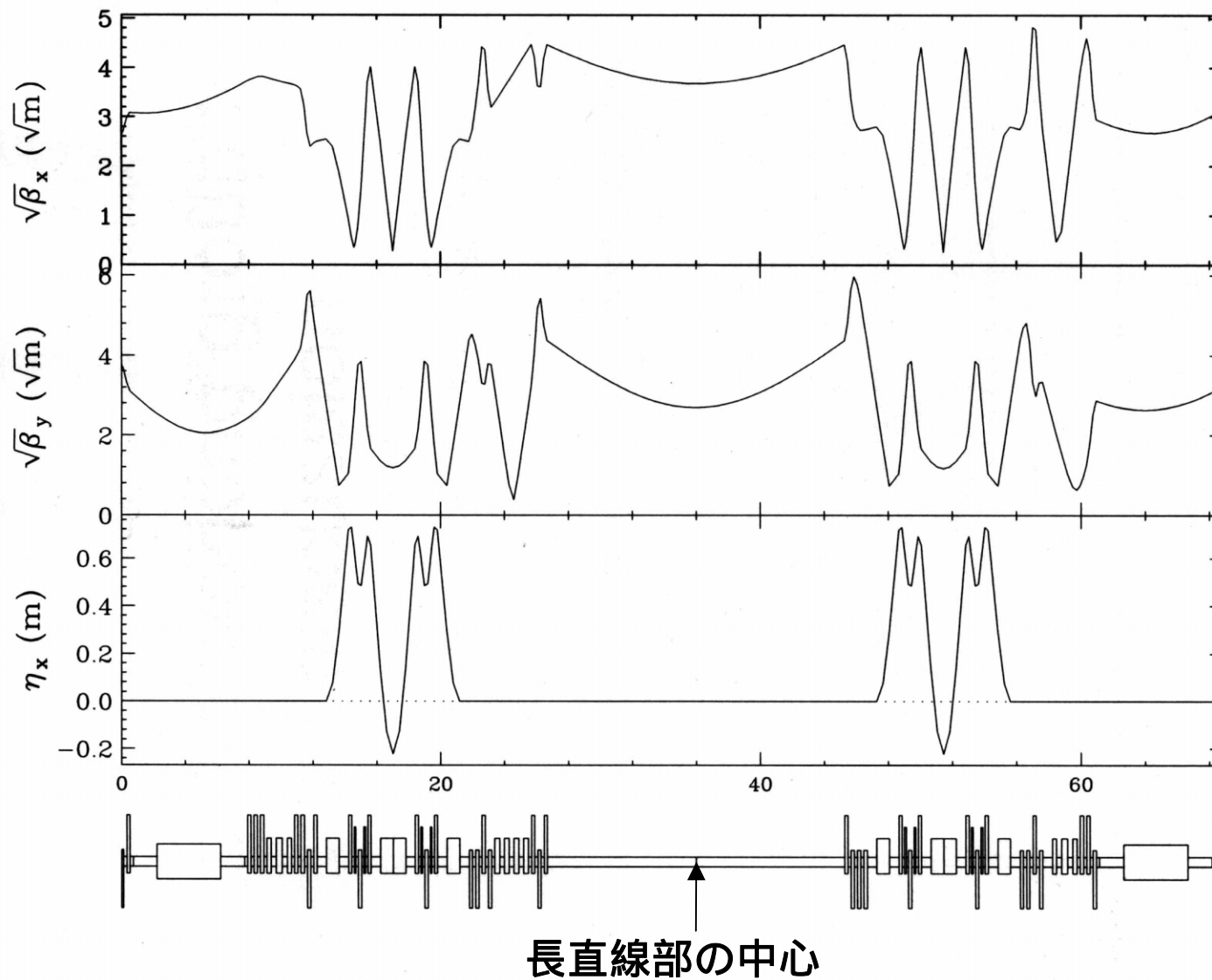

Arc1部

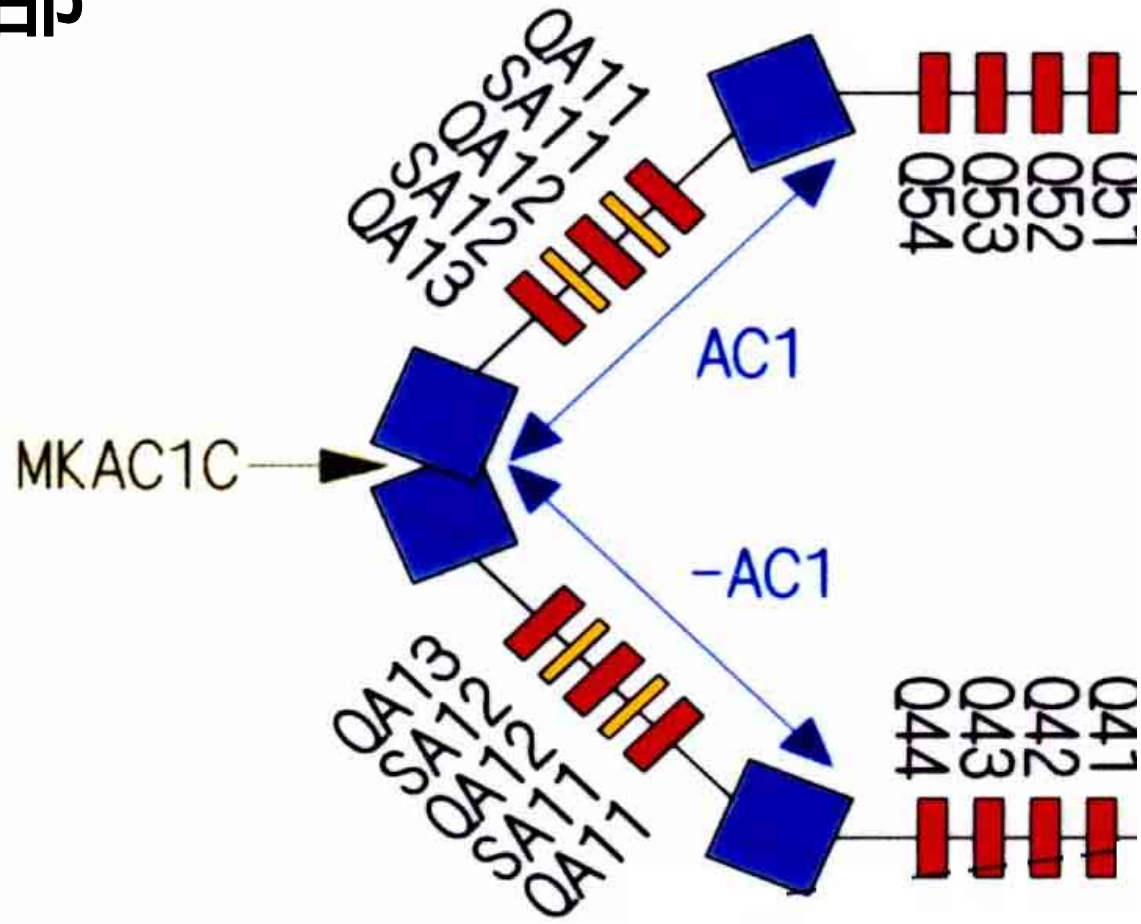

Dispersion

- 赤：ビームサイズ測定
Emittance評価
Halo測定
Dispersionなし
- 緑：ビームサイズ測定
Dispersion評価
光学的ビーム位置
測定PBPM
- 青：Halo測定
Dispersionあり

全ての四極にはBPMをつける
Arcの中心にはBPMがつけられるか？

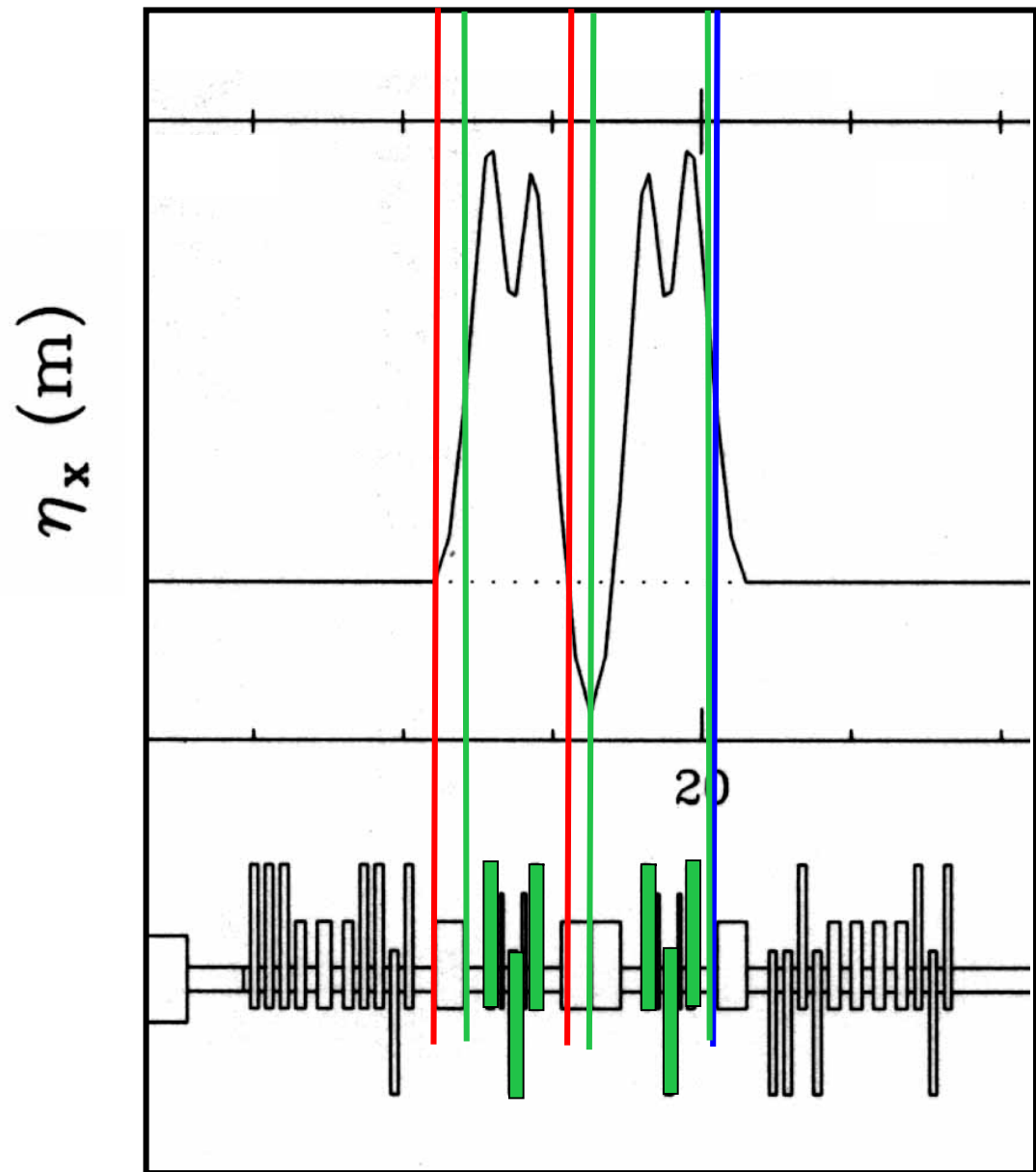

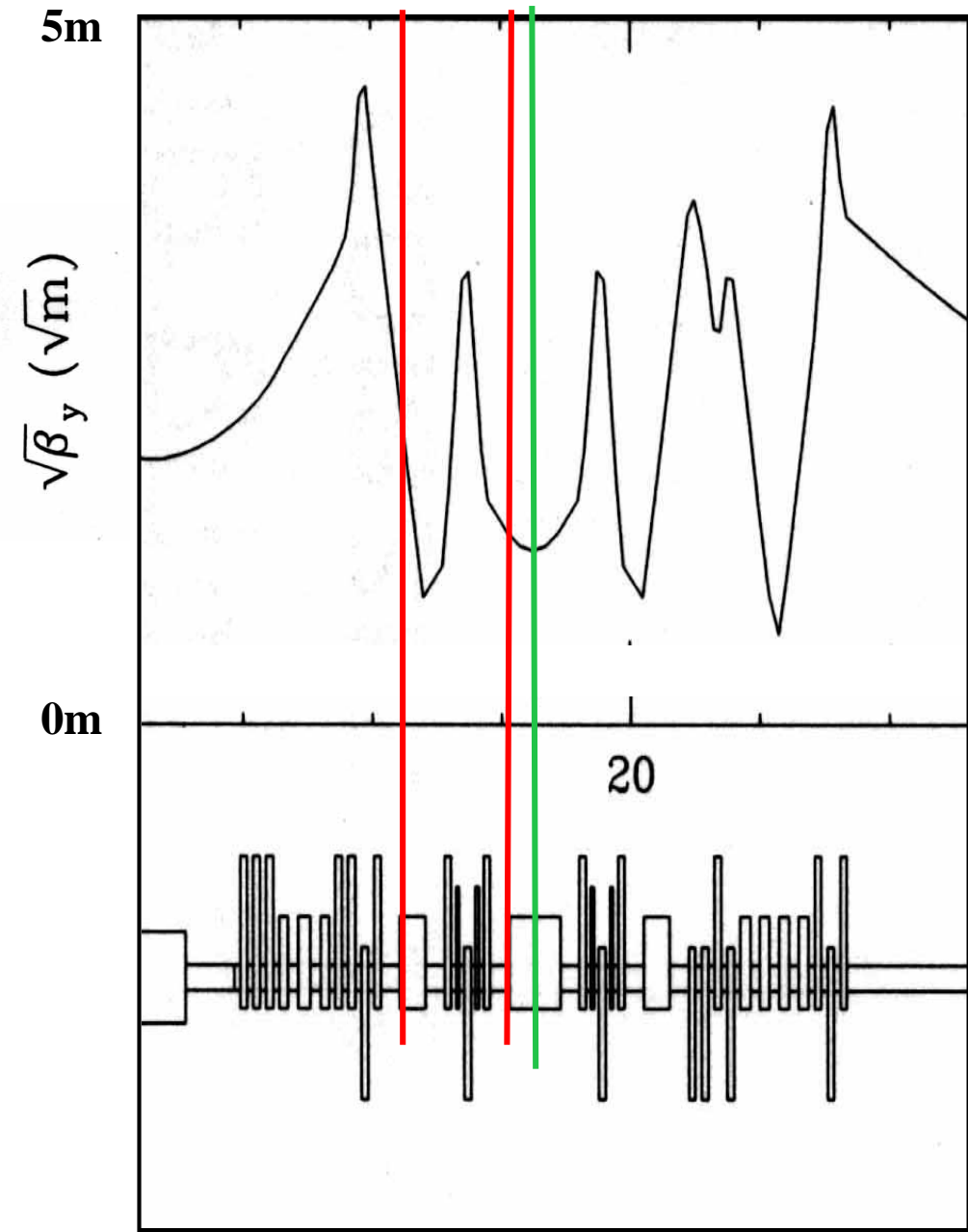

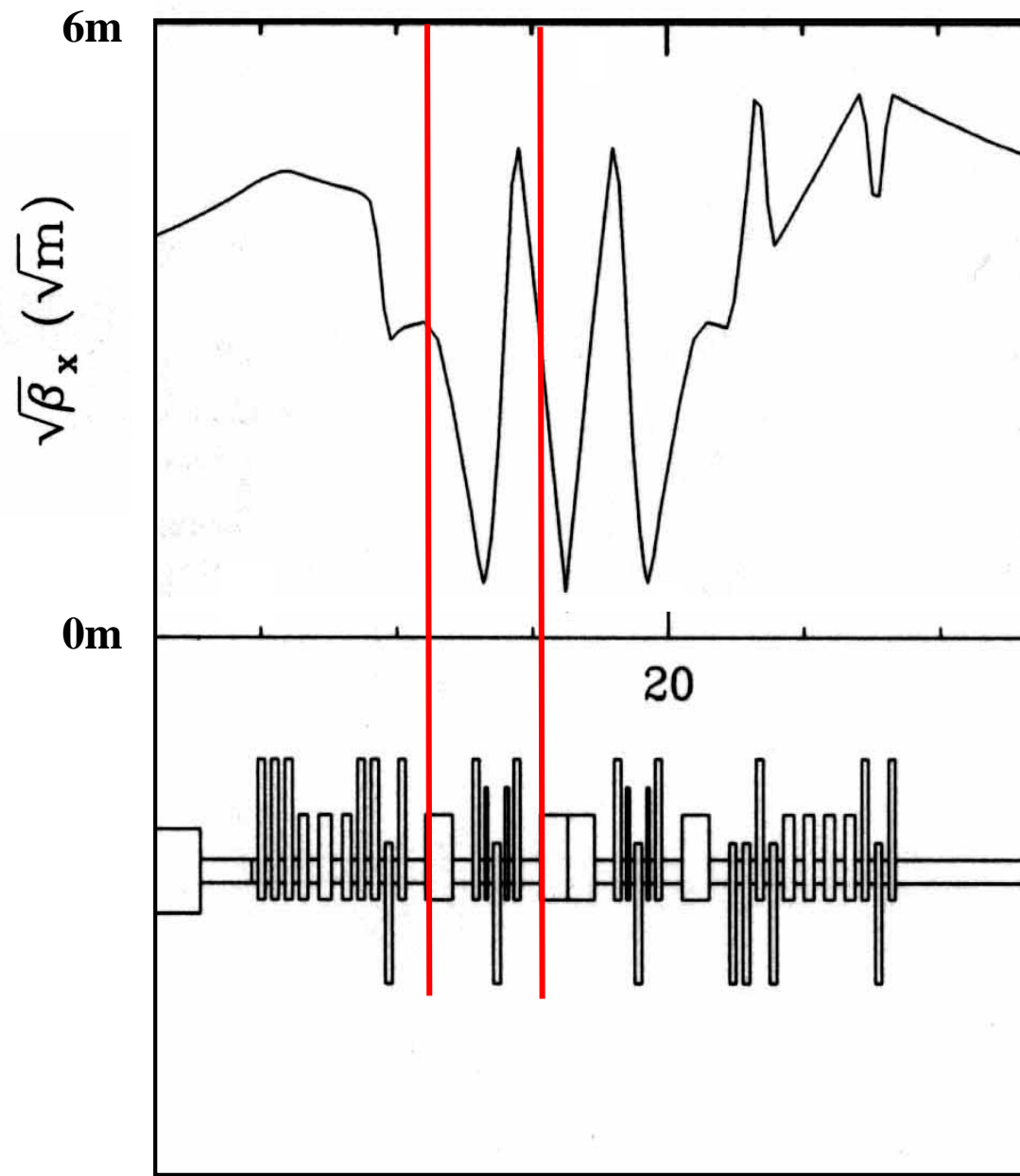

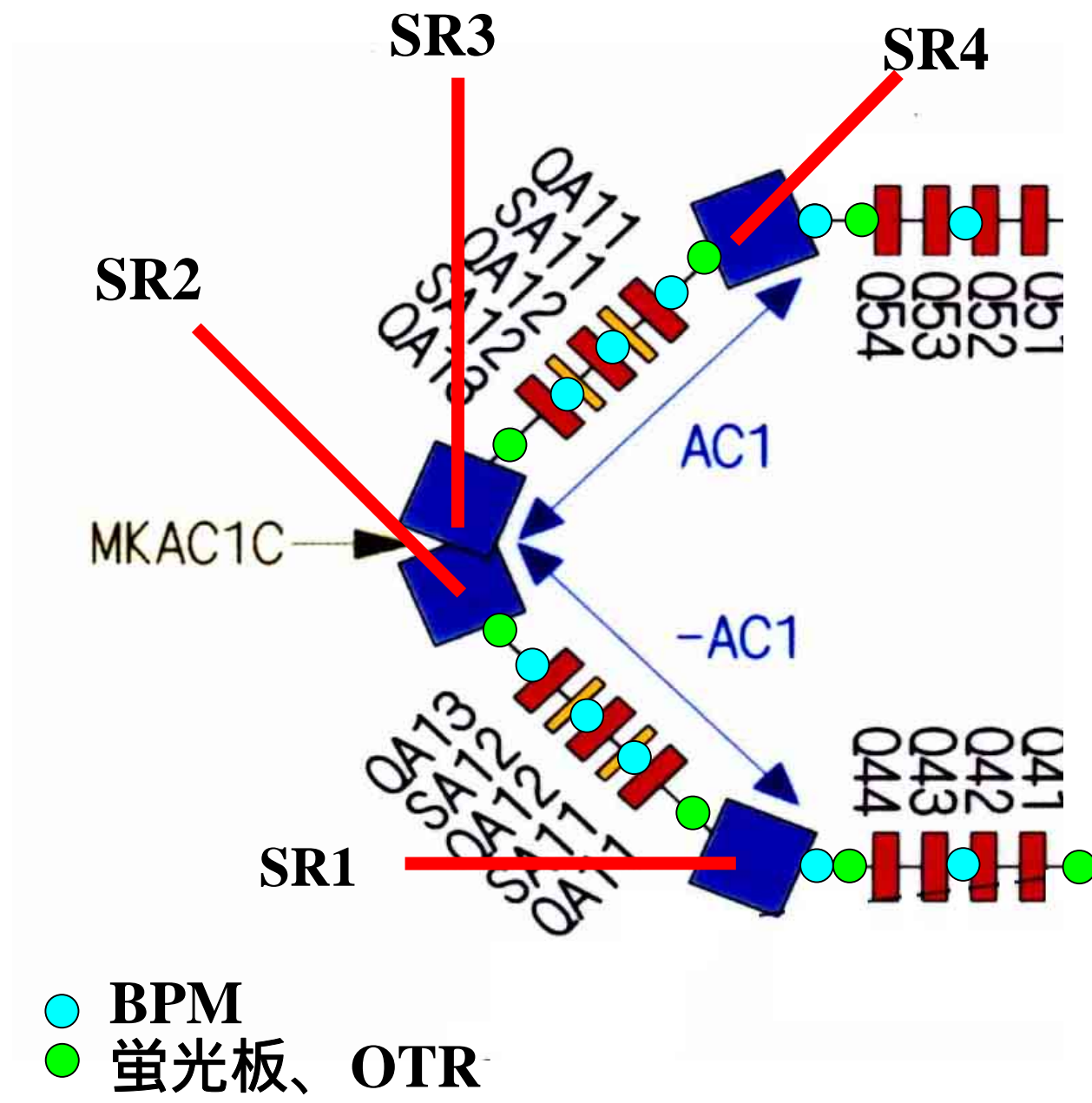

入射部および加速空洞直線部

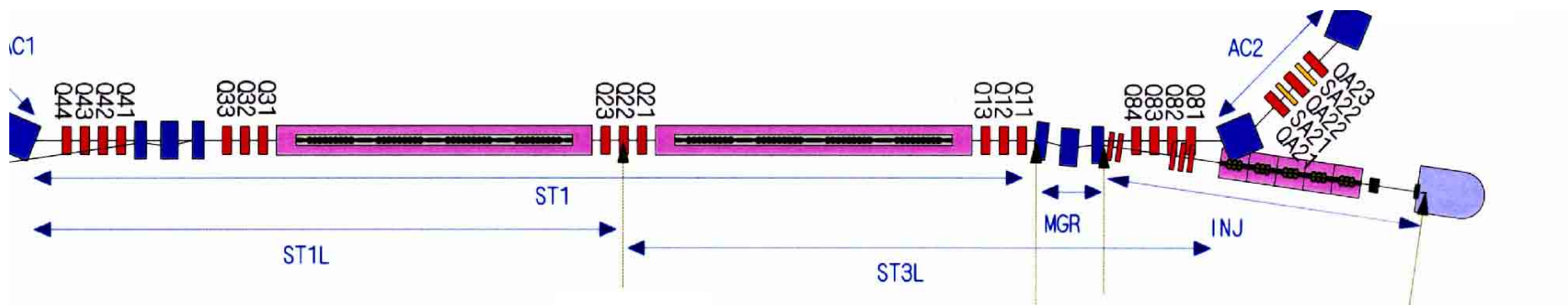

入射部

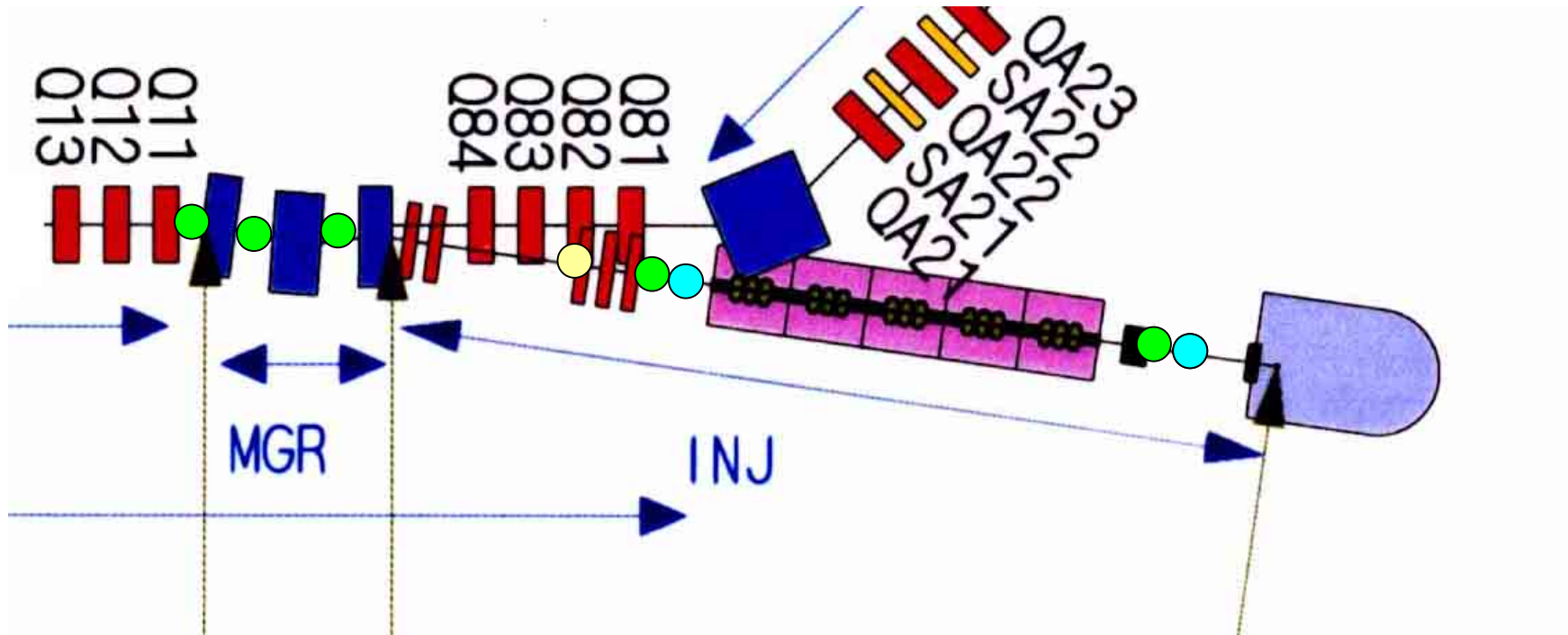

- 蛍光板またはスリット付蛍光板 (emittance 評価)
- BPMストリップライン
- ワイヤースキャナーまたはSEM

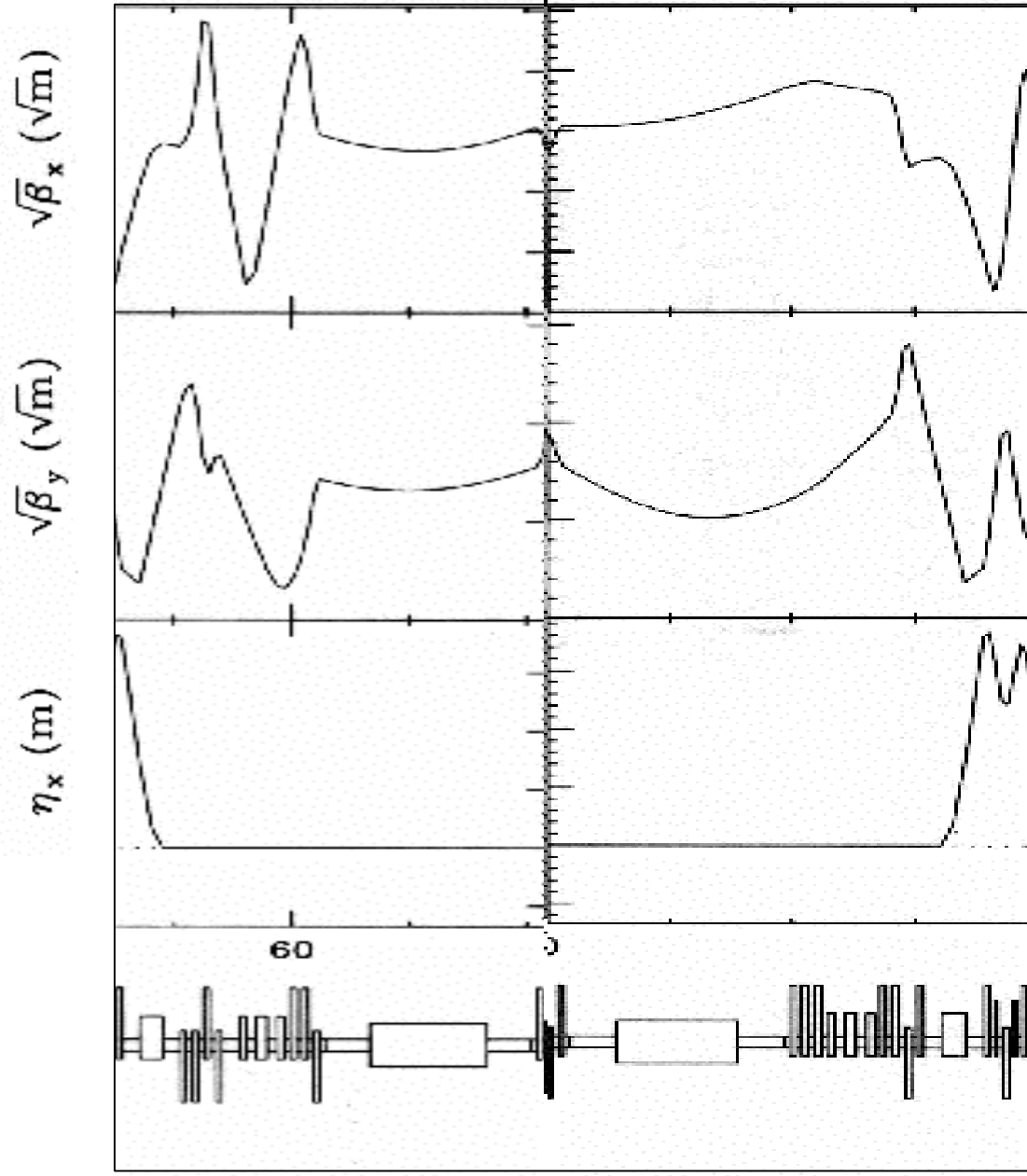

- BPM
- OTR, 蛍光板

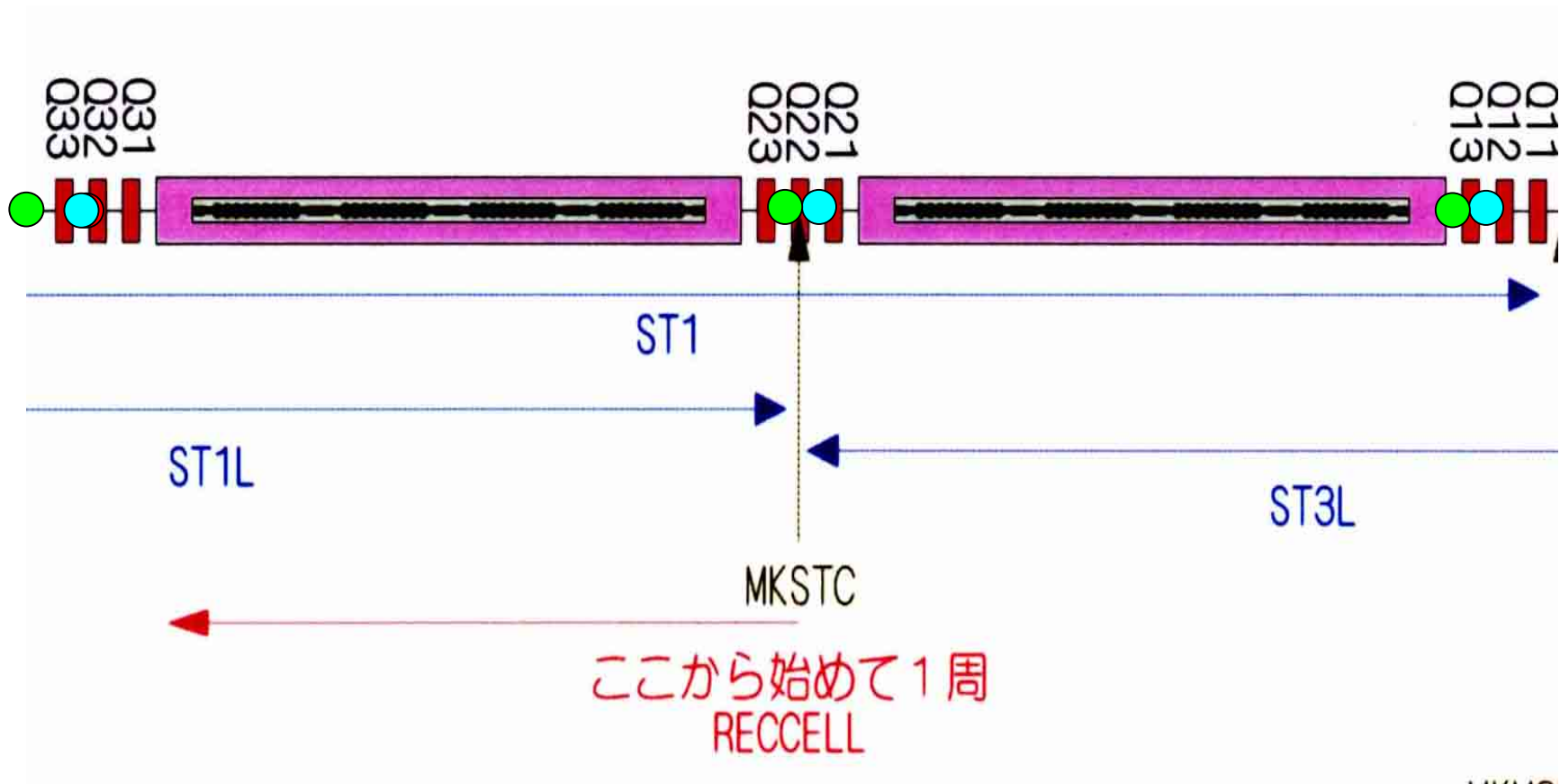

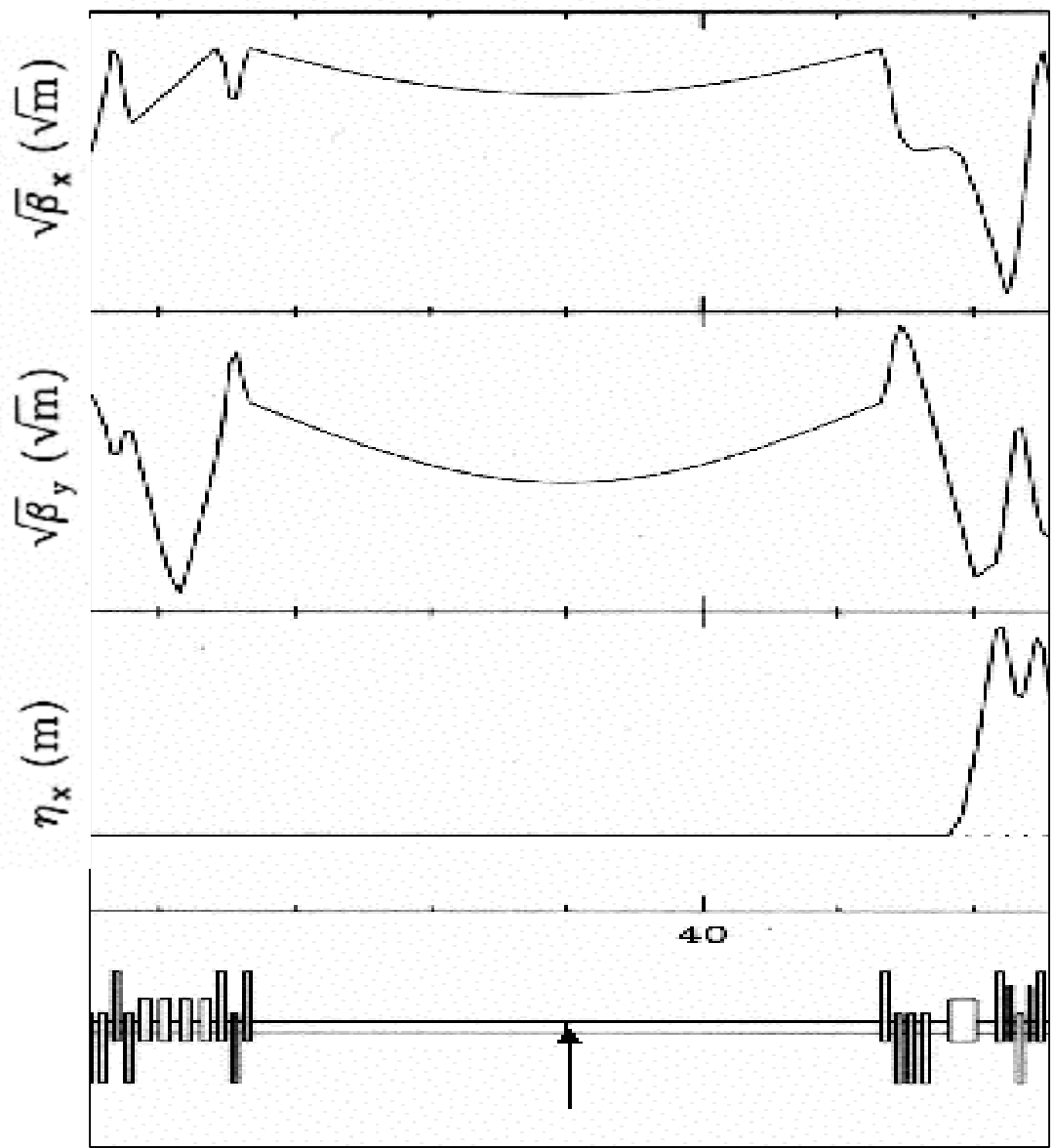

- cavity BPM
- BLM (one pass, Opto-electric type)

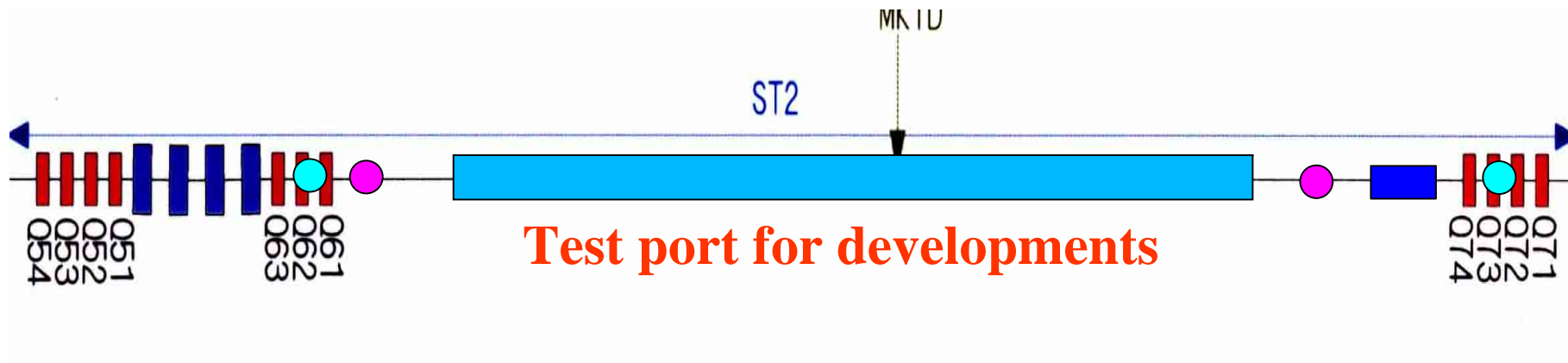

- differential DCCT for current valance

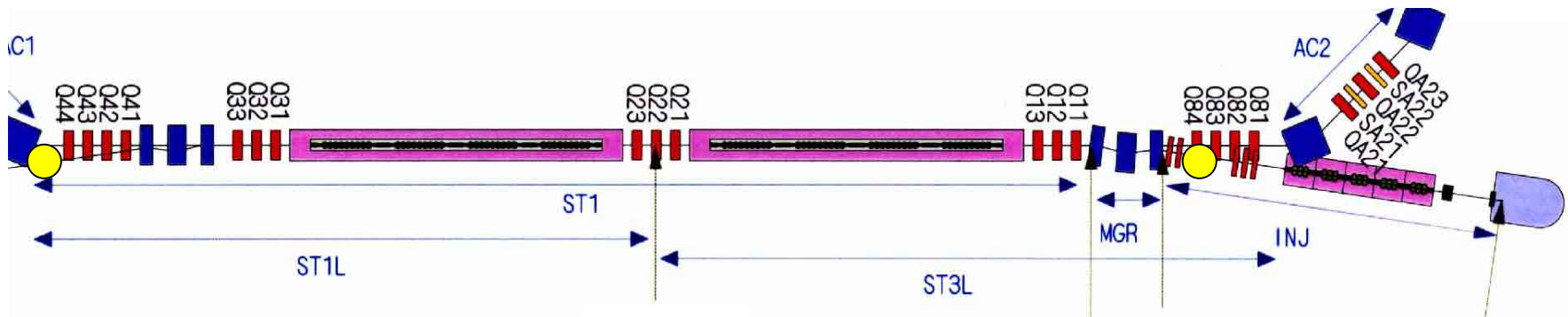

Arc2部

- BPM
- 蛍光板, OTR

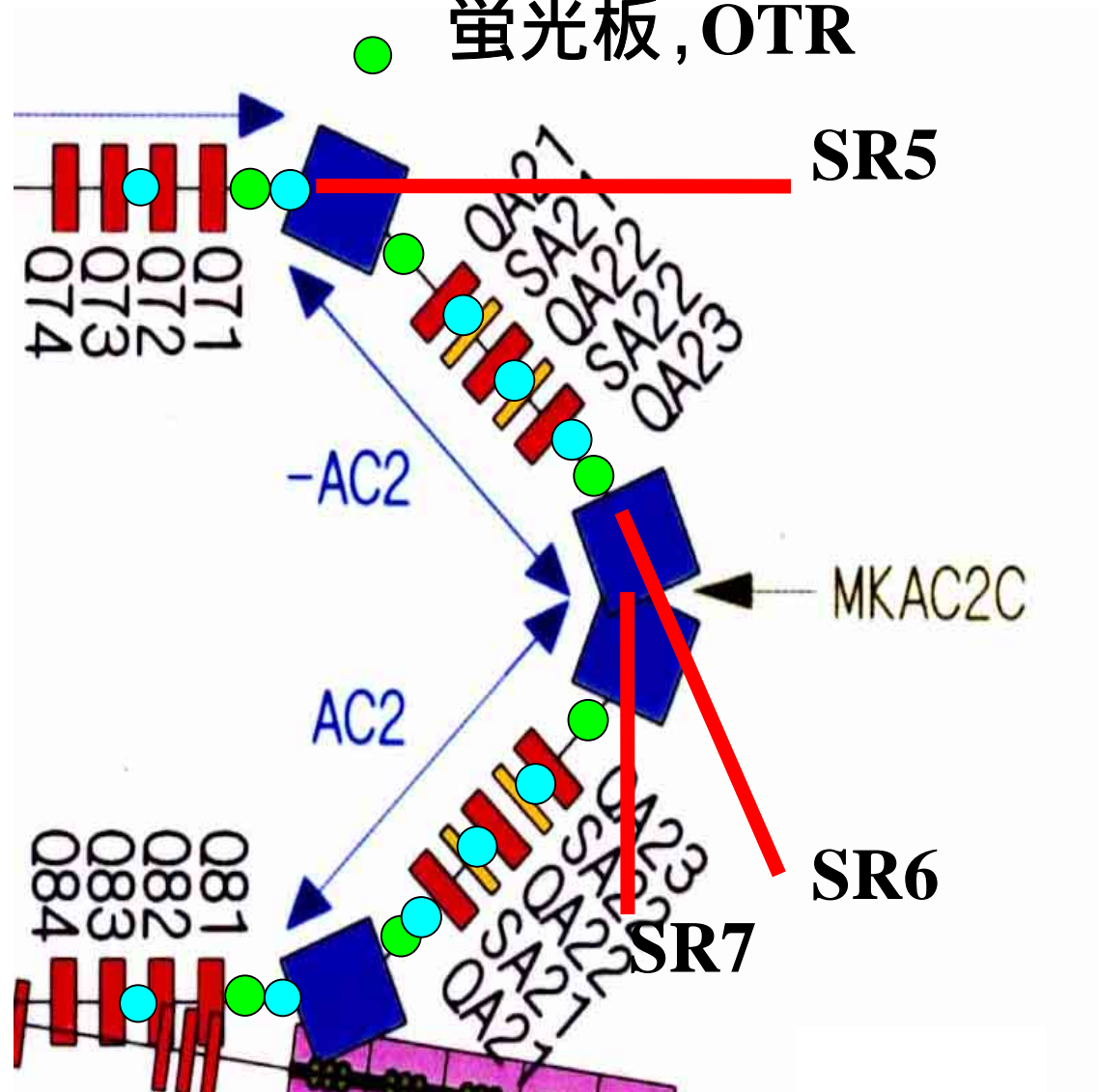

Dump line

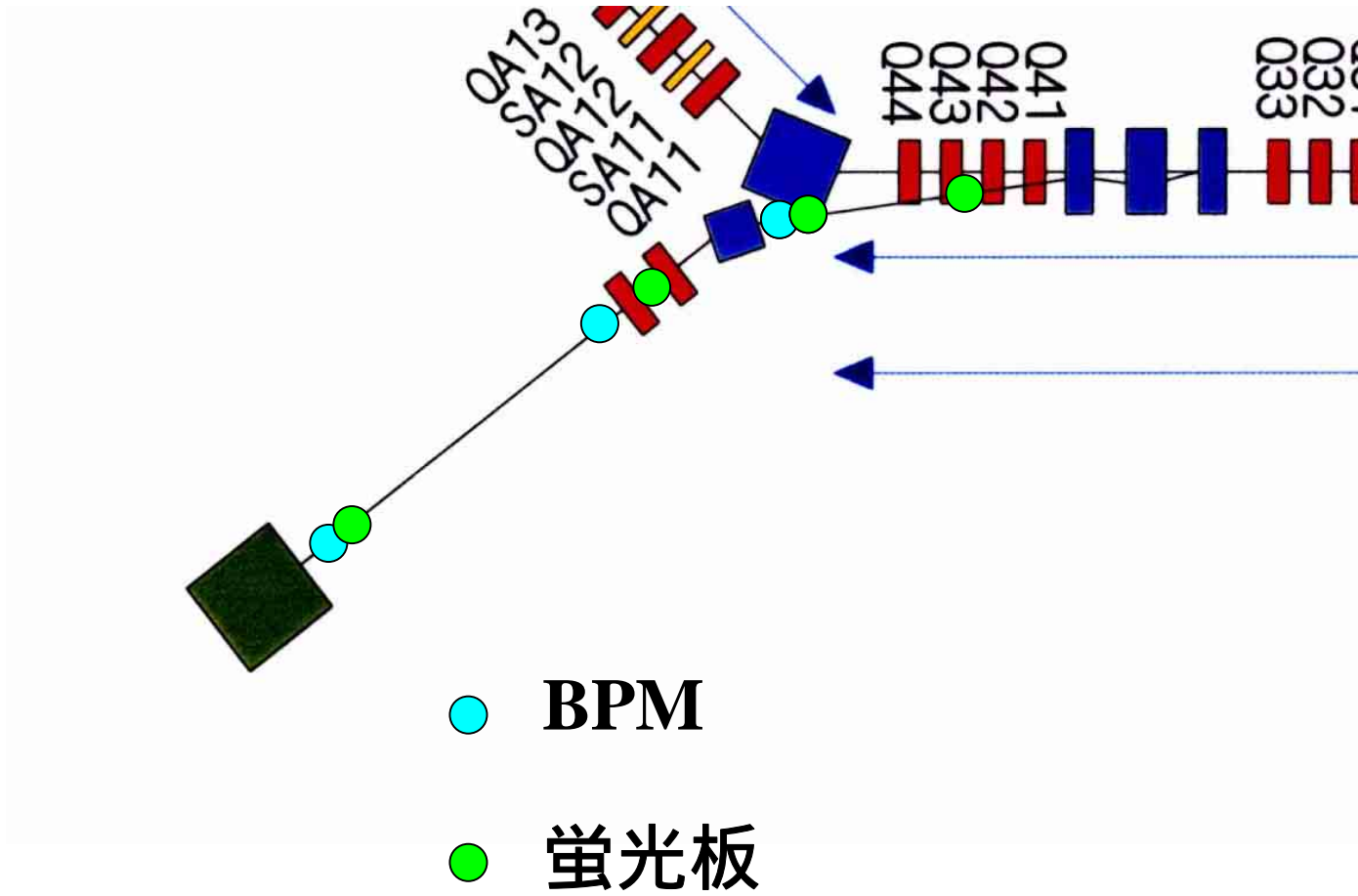

	Device		Accuracy	Resolution	Comment
Injector	BPM(strip line)	2			Position, timing
	Fluorescence screen	2			Position, profile
	Fluorescence screen (with slit)	2			Emittance
	Wire scanner SEM mode	1			Emittance, Halo
Merger	Fluorescence screen	4			Position, profile
Straight1 cavity	BPM	3			Position, timing, phase
	Fluorescence screen	3			Position, profile
	OTR	1			Position, profile
Arc1	BPM	8			Position, timing, phase
	BPMSR	1			Position
	Fluorescence screen	6			or OTR Position, profile
	SR	3			SRI, Streak camera Halo, profile

Straight 2	BPM	2			Position, timing, phase
	Cavity BPM	2			Accurate Position
	Test section				development
	BLM (Opto-electric)				Bunch length
Arc2	BPM	8			Position, timing, phase
	BPMSR	1			Position
	Fluorescence screen	6			or OTR Position, profile
	SR	3			SRI, Streak camera Halo, profile
Others	Differential DCCT	1			Current difference
	DCCT	1			DC current
	WCM	1			Bunch by bunch Current
Dump line	Fluorescence screen	4			Position, profile
	BPM	3			Position

Test facility for short pulse beam at PFBT

Development of beam monitors

Development of fs technology

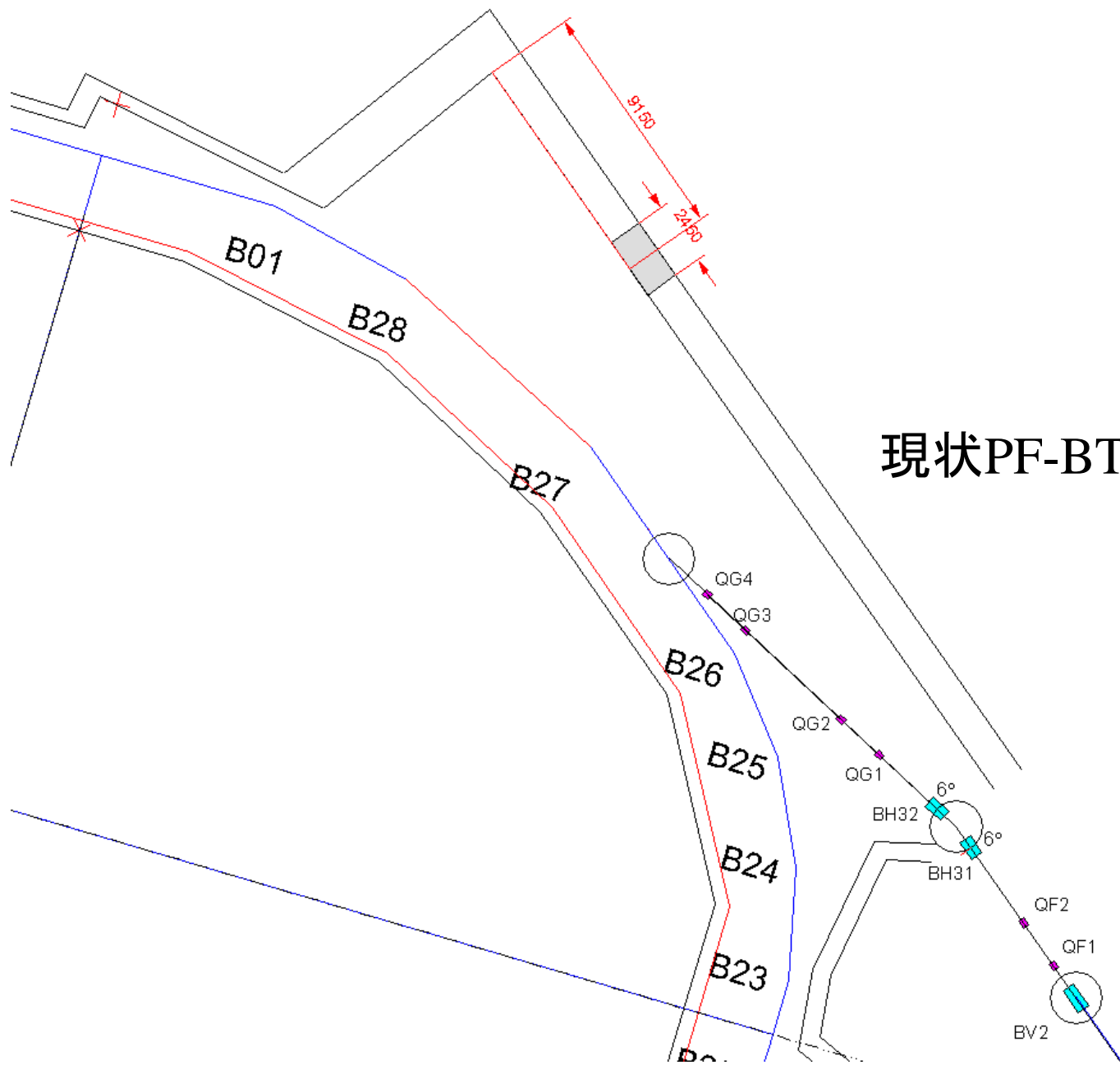

現状PF-BT

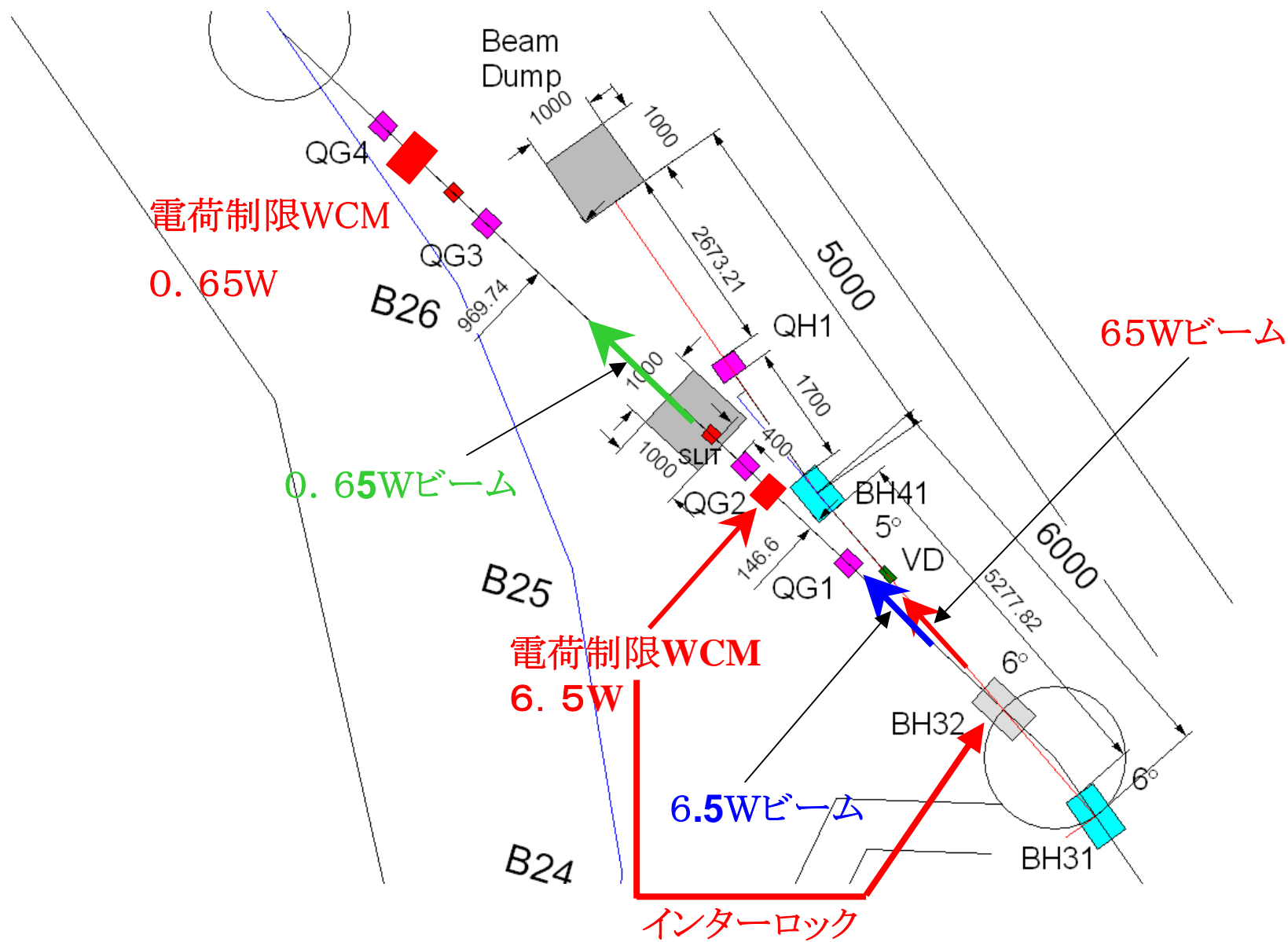

0.6ps to 4psec 60W (2.5GeV,1nc, 25pps)

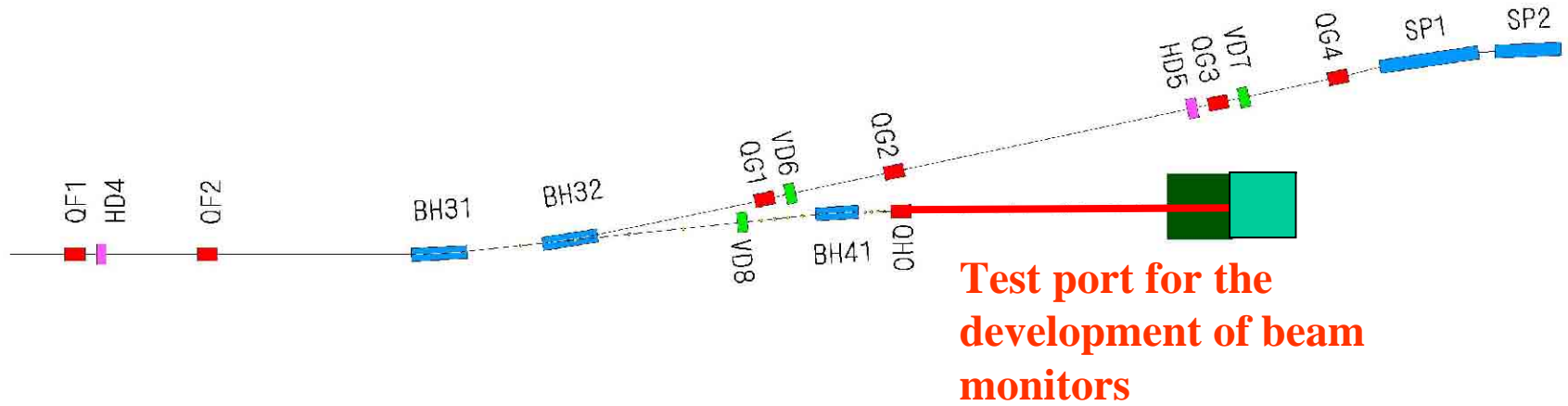

$$\epsilon_x = 40 \text{ (nm*rad)}$$

$$\epsilon_y = 13 \text{ (nm*rad)}$$

Phase Space Plot of Injected Beam

Beam : at the position of BH31

BH31 入口

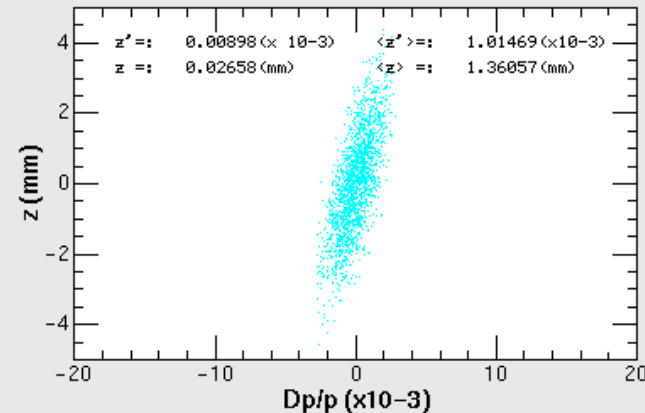
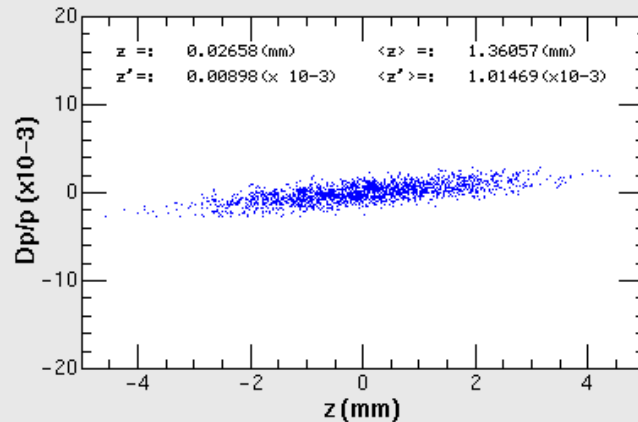
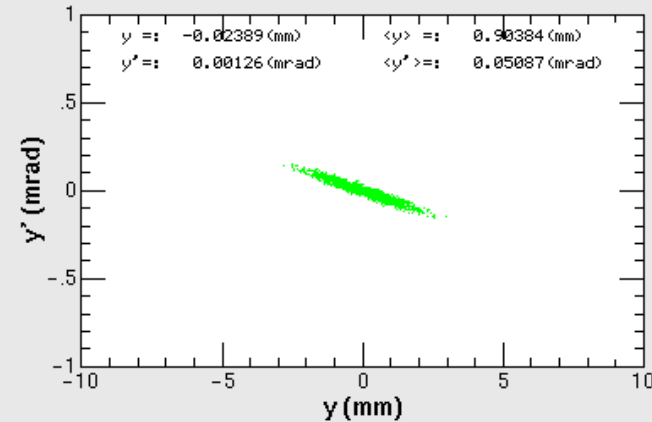
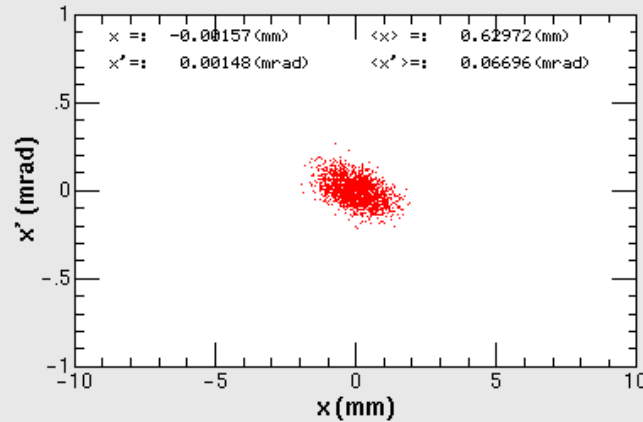

$$\sigma_z = 1.4 \text{ (mm)} = 4.2 \text{ (psec)}$$

$$\sigma_\epsilon = 1.0 \times 10^{-3}$$

$$R56 = 1.0 \text{ (m)}$$

Normal : BK-BH31間

$$\epsilon_x = 40 \text{ (nm*rad)}$$

$$\epsilon_y = 13 \text{ (nm*rad)}$$

Phase Space Plot of Injected Beam

Beam : at the position of BH31

BH31 入口

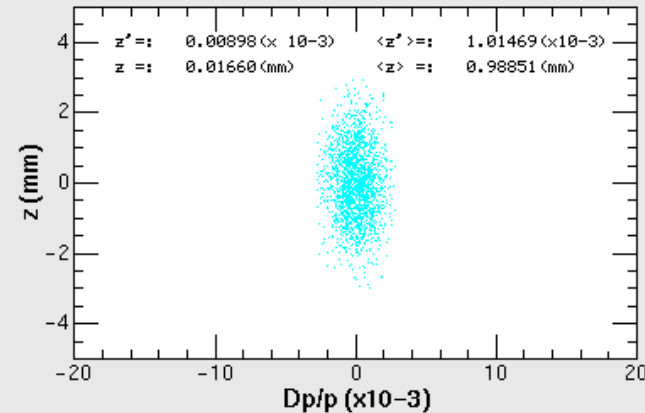
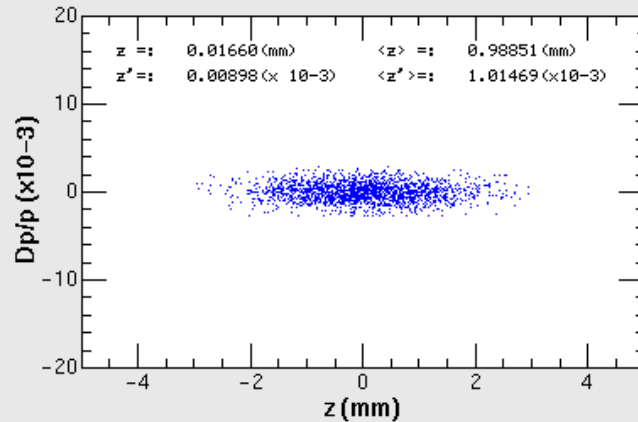
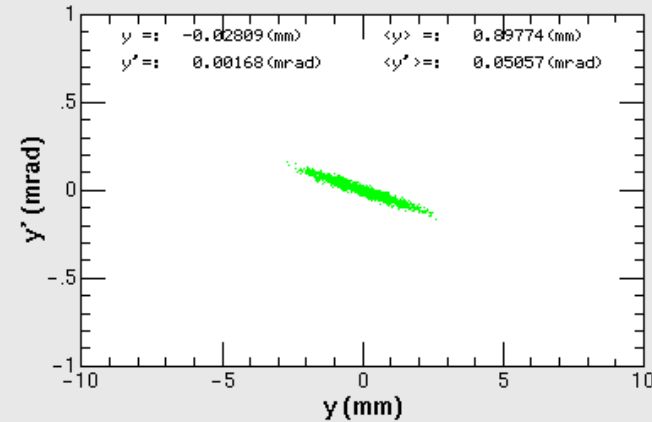
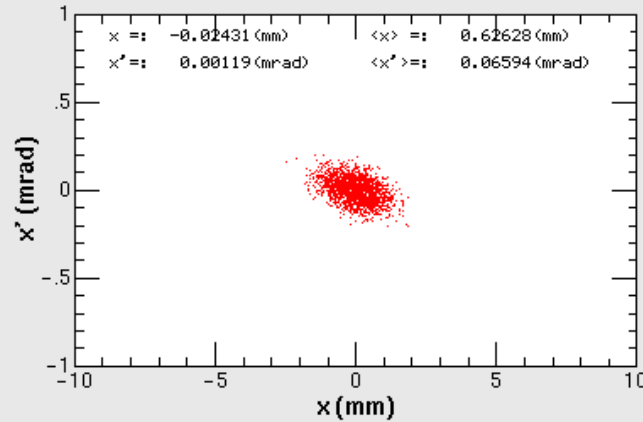

$$\sigma_z = 0.99 \text{ (mm)} = 3.3 \text{ (psec)}$$

$$\sigma_\epsilon = 1.0 \times 10^{-3}$$

$$R56 = 0.0 \text{ (m)}$$

Isochronous: BK-BH31間

$$\epsilon_x = 40 \text{ (nm*rad)}$$

$$\epsilon_y = 13 \text{ (nm*rad)}$$

Phase Space Plot of Injected Beam

Beam : at the position of BH31

BH31 入口

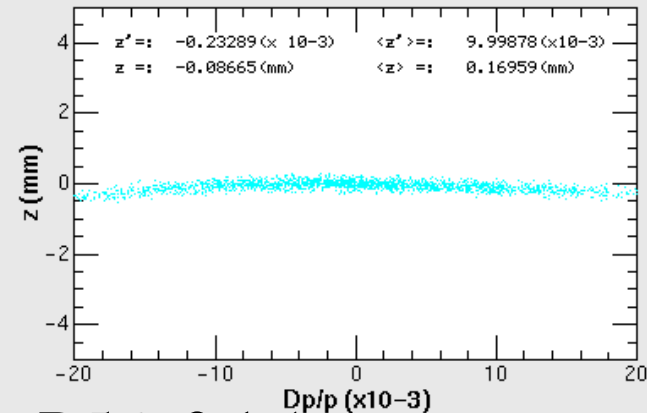
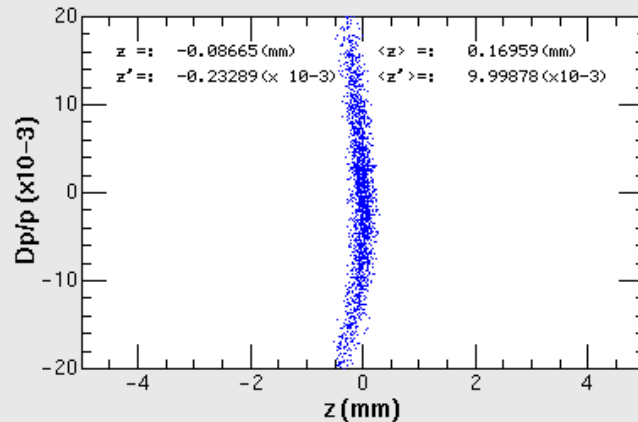
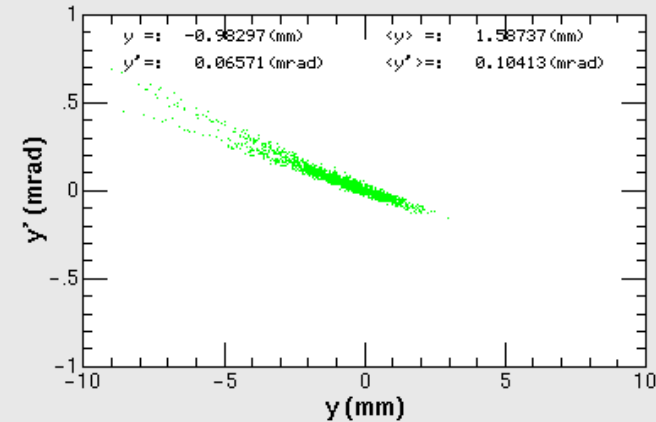
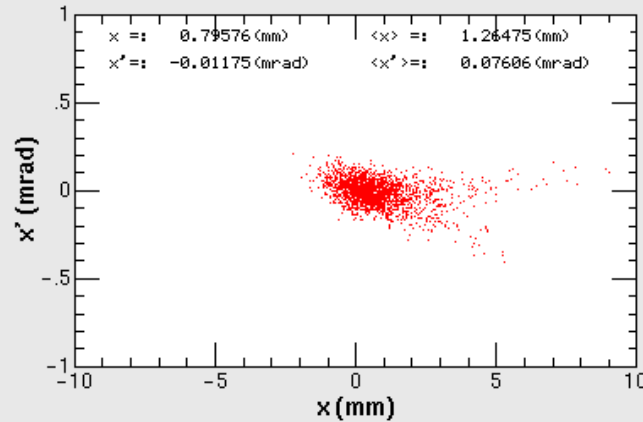

$$\sigma_z = 0.17 \text{ (mm)} = 0.57 \text{ (psec)}$$

$$\sigma_\epsilon = 10.0 \times 10^{-3}$$

$$R56 = 0.1 \text{ (m)}$$

$$T566 = -0.11 \text{ (m)}$$

Bunch Compress: BK-BH31間

**Beam instrumentation based on
Optical and opto-electric method**

**Incoherent SR intensity
Interferometry
for
Short bunch measurement**

Bunch length measurement by intensity interferometry

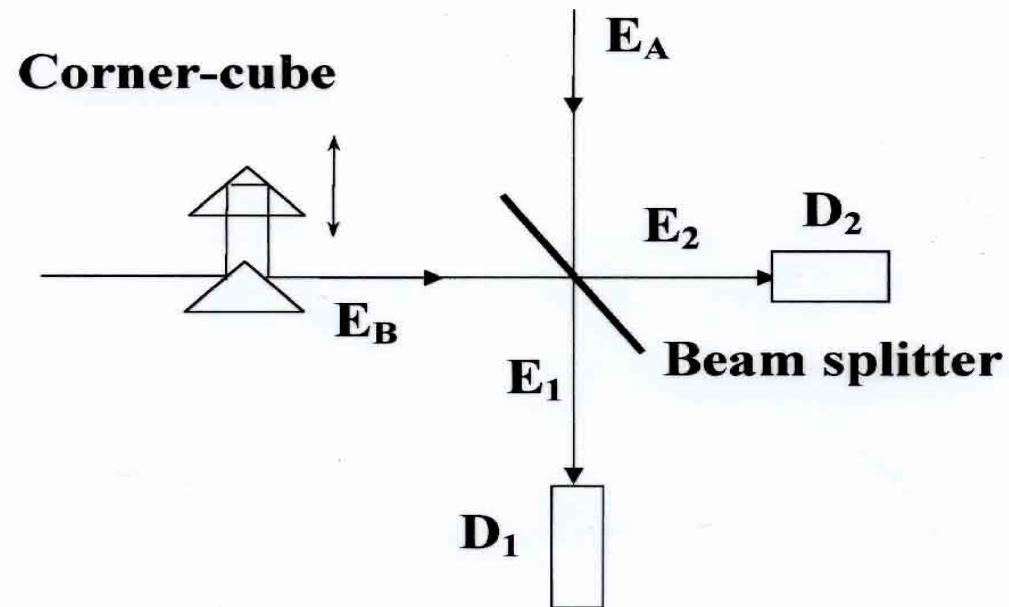

Input fields for a beam splitter in intensity interferometry.

Let us represent the incident optical field by the complex field ,

$$\begin{aligned} E_A(t) &= C_A(t)A_A(t) \\ E_B(t) &= C_B(t)A_B(t) . \quad -(3) \end{aligned}$$

Here $C(t)$ is the pulse envelope having a pulse width (bunch length) σ_p , and $A(t)$ is a stationary random variable having coherence time τ_c .

We assume the correlation function of $A(t)$ and $C(t)$ have Gaussian shape. We also assume that E_A and E_B of two photons have no first order coherence. We thus obtain from Eq. (2), remormalizing the proportional constant K ,

$$\begin{aligned} \text{Count}_{12}(\delta\tau) &= K\sigma_p^2 \left(1 + \frac{\tau^*}{\sigma_p} \left[1 - \frac{1}{2} \exp\left(-\frac{\delta\tau^2}{4\sigma_p^2}\right) \right] \right), \\ \frac{1}{\tau^{*2}} &= \frac{1}{\sigma_p^2} + \frac{1}{\tau_c^2} . \end{aligned}$$

Let us represent the incident optical field by the complex field ,

$$\begin{aligned} E_A(t) &= C_A(t)A_A(t) \\ E_B(t) &= C_B(t)A_B(t) . \end{aligned}$$

Here $C(t)$ is the pulse envelope having a pulse width (bunch length) σ_p , and $A(t)$ is a stationary random variable having coherence time τ_c .

We assume the correlation function of $A(t)$ and $C(t)$ have Gaussian shape.

We thus obtain coincidence count;

$$\text{count}_{12}(\delta\tau) = K\sigma_p^2 \left[1 - \frac{1}{2} \exp\left(-\frac{\delta\tau^2}{4\tau_c^2}\right) + \frac{\tau^*}{\sigma_p} \left(1 - \frac{1}{2} \exp\left(-\frac{\delta\tau^2}{4\sigma_p^2}\right) \right) \right]$$

$$\frac{1}{\tau^{*2}} = \frac{1}{\sigma_p^2} + \frac{1}{\tau_c^2} .$$

Illustration of intensity interference pattern with coherent light pulse.

Phase correlation peak in the center.

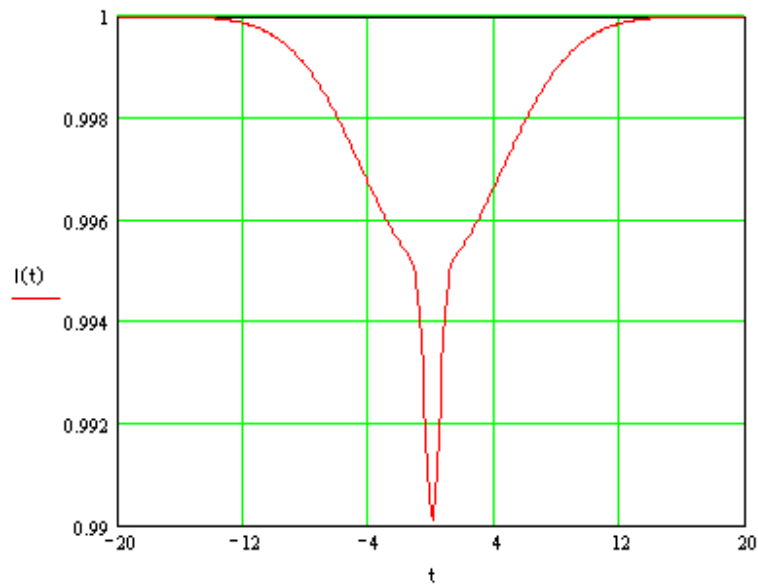
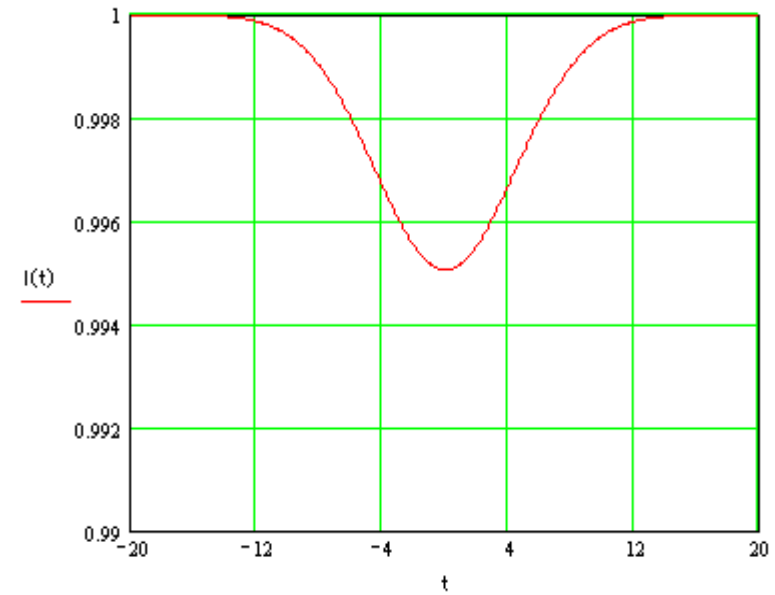
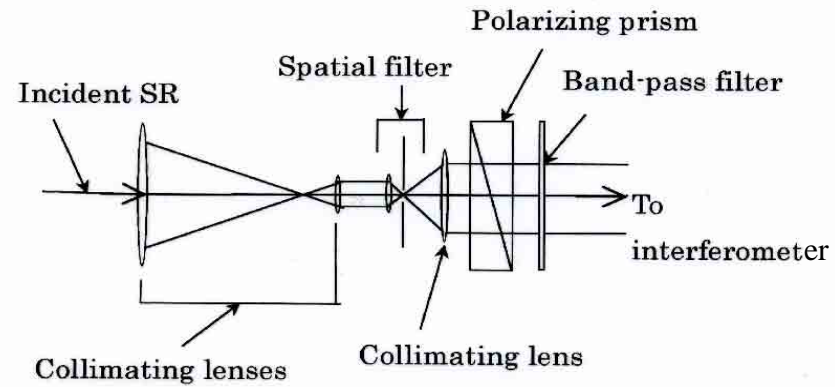

Illustration of intensity interference pattern with chaotic light pulse.



Experimental setup of the intensity interferometer



(a) Set up of first-stage system to produce an incidence beam for the interferometer

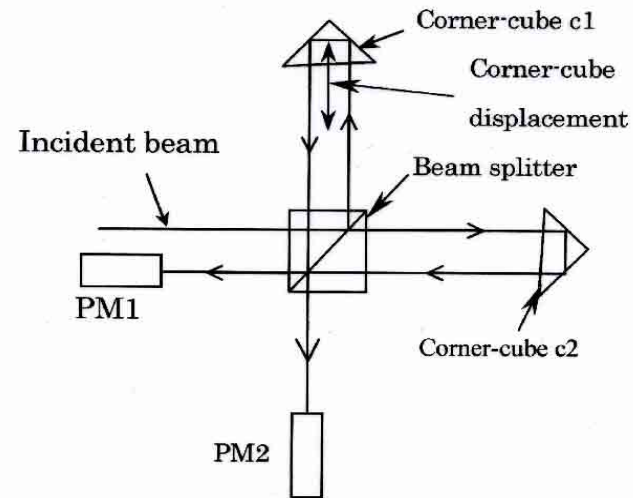

(b): Set-up of intensity interferometer.

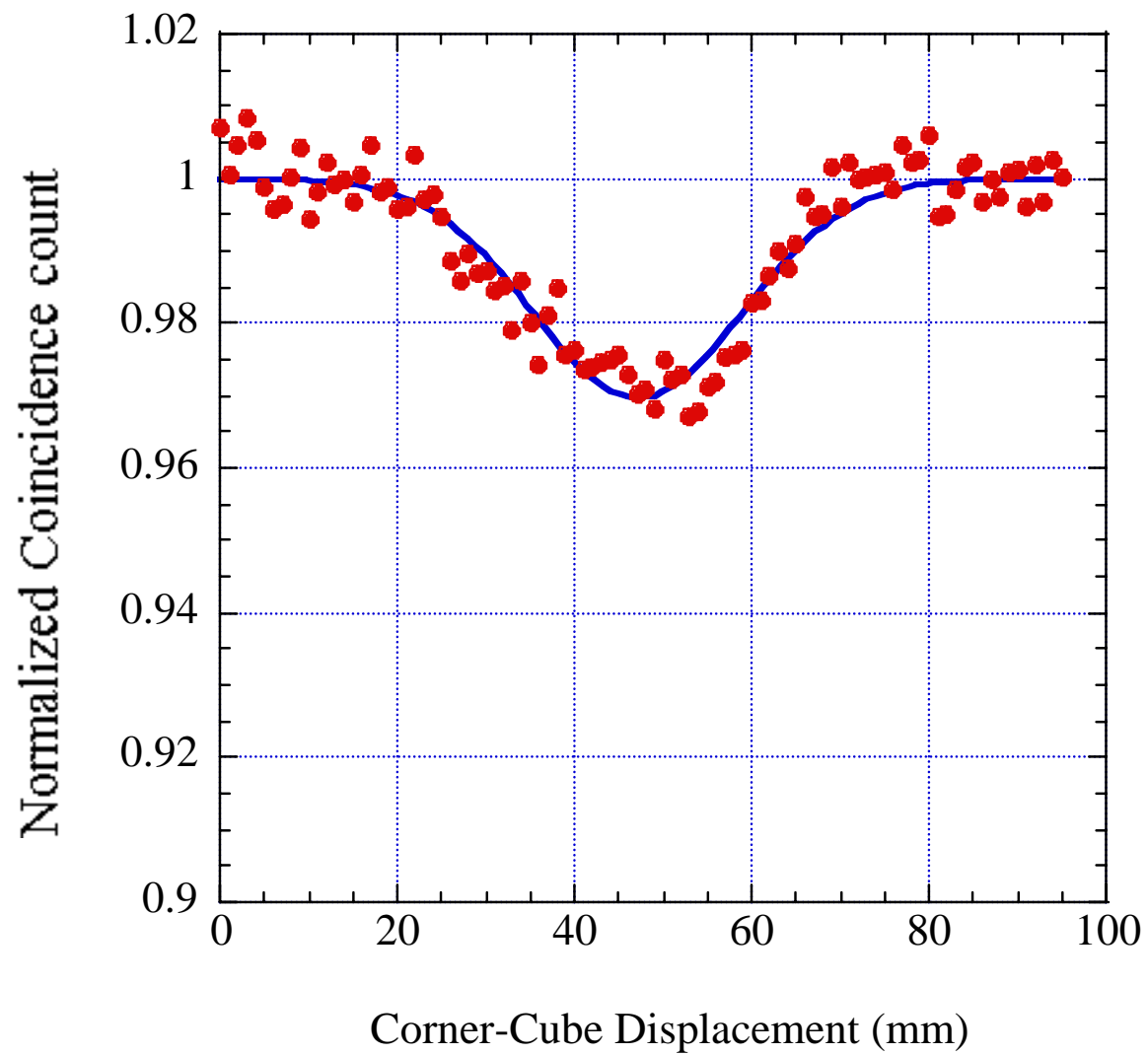

Pulse envelope length σ_p is always longer than Coherent length of wave pockets τ_c .

$$\sigma_p \geq \tau_c$$

We can measure the very short pulse length with intensity interferometry with **nearly no theoretical limit on temporal resolution.**

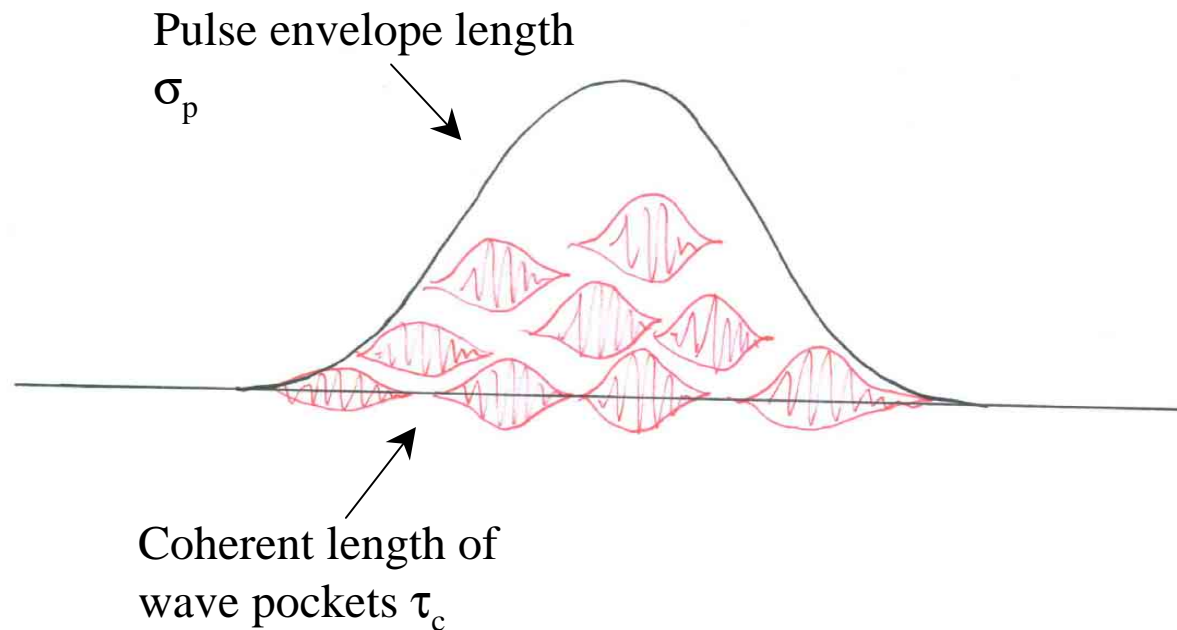

Actual resolution will be limited by dispersion of the glass.

Coronagraph for halo measurement

Optical layout of the coronagraph

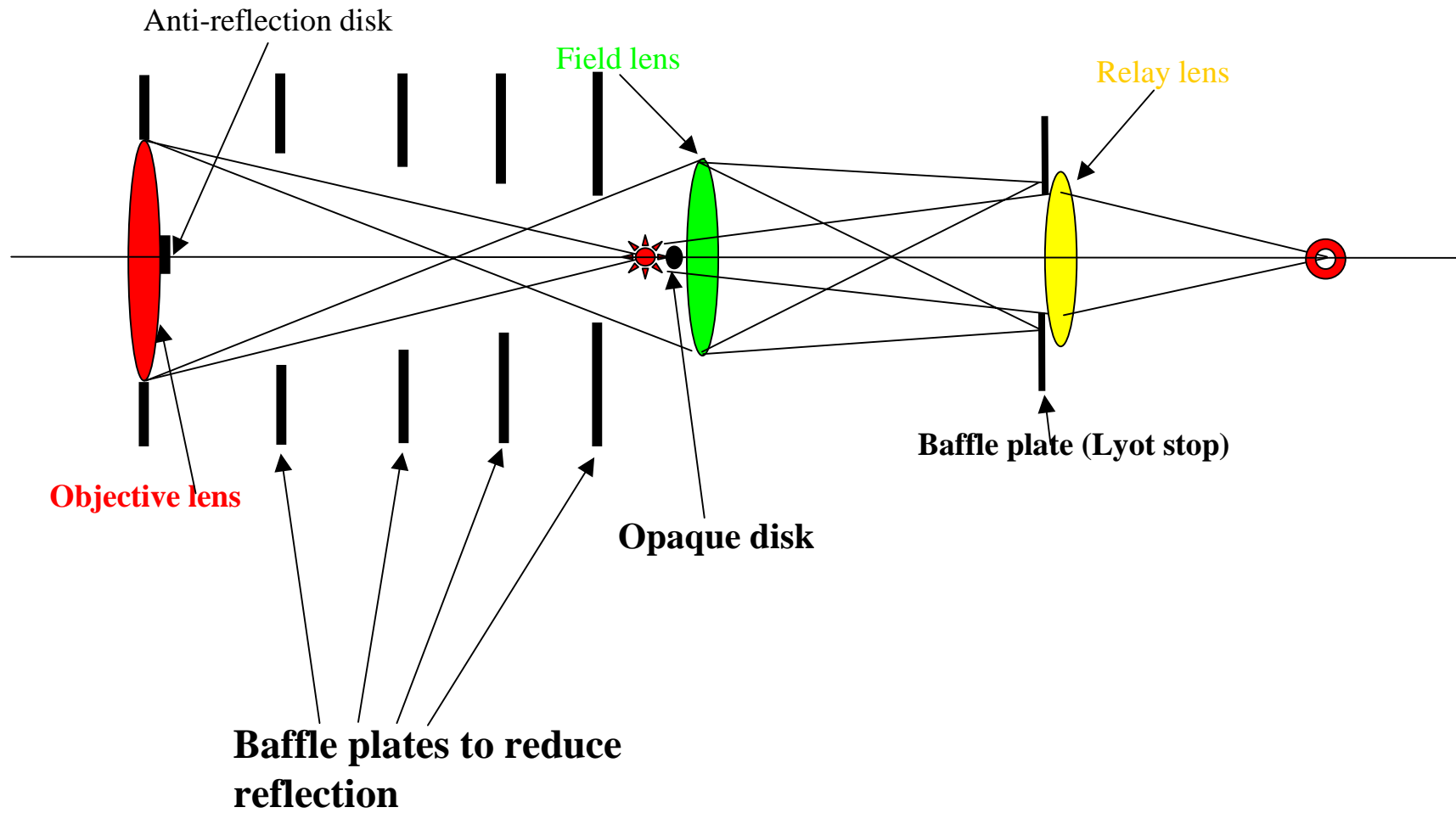

Beam tail images in the single bunch operation at the KEK PF measured at different current

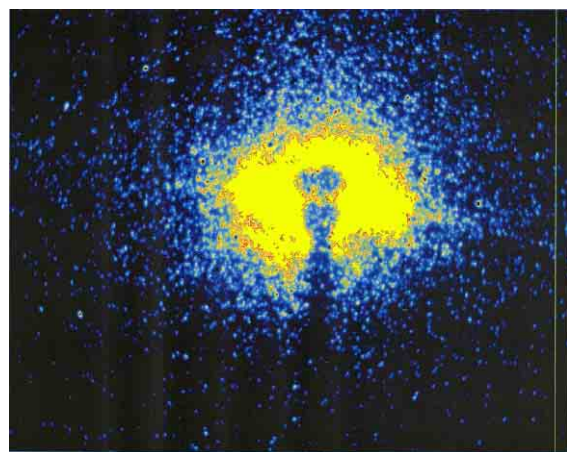

65.8mA

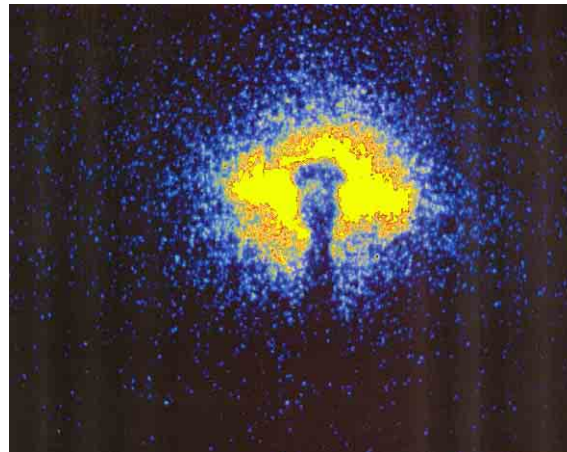

61.4mA

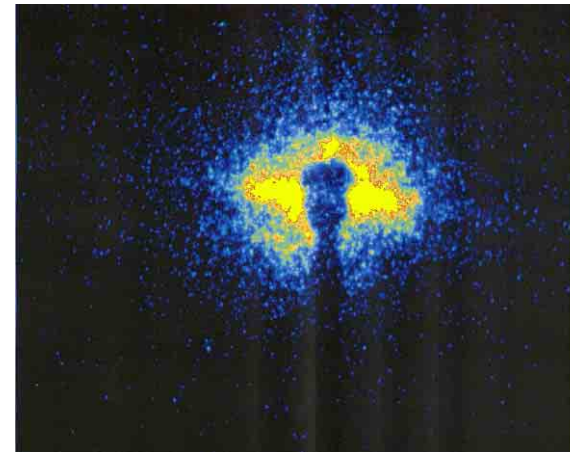

54.3mA

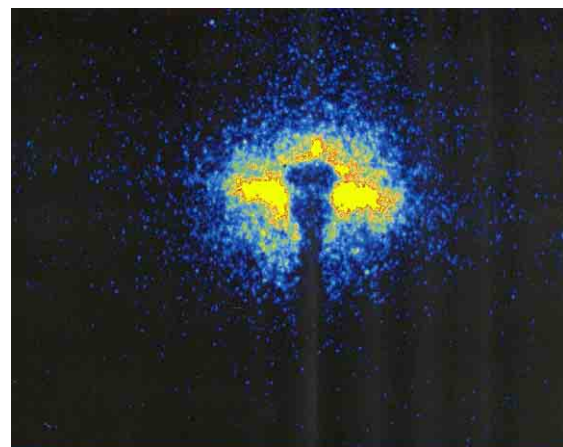

45.5mA



35.5mA

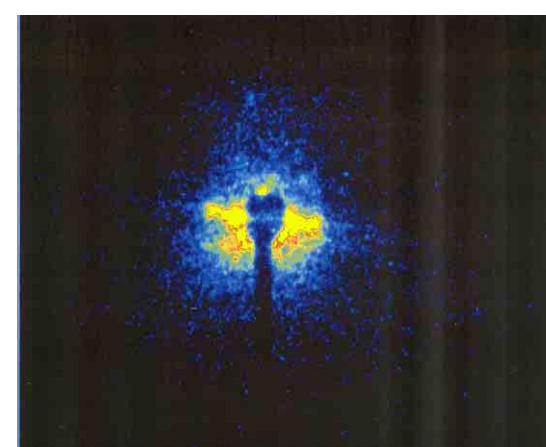

396.8mA
Multi-bunch
bunch current 1.42mA

Observation for the more out side

**Single bunch
65.8mA**

**Exposure time
of CCD : 3msec**

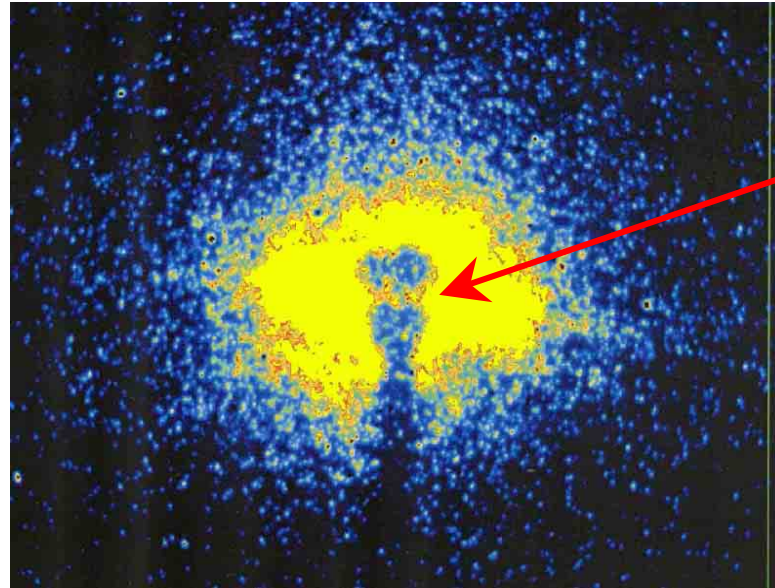

Intensity
in here :
 2.05×10^{-4}
of peak
intensity

Far tail

**Exposure
time of CCD :
100msec**

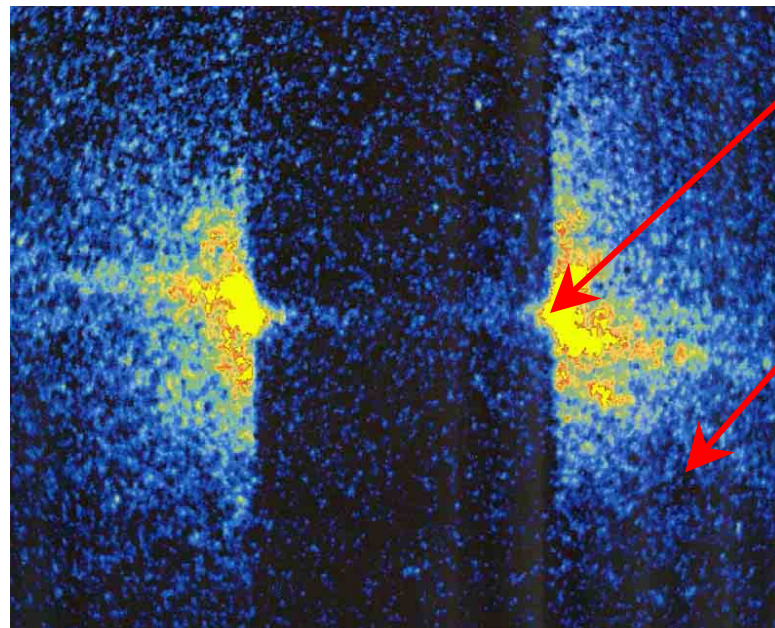

2.55×10^{-6}

Background
level : about
 6×10^{-7}

**Bunch length monitoring
by Opto-electric method**

Electro-Optical Sampling

1. Sampling:

- simple analysis
- balanced detector allows high sensitivity
- good synchronization required
- multi-shot method
- arbitrary time window possible

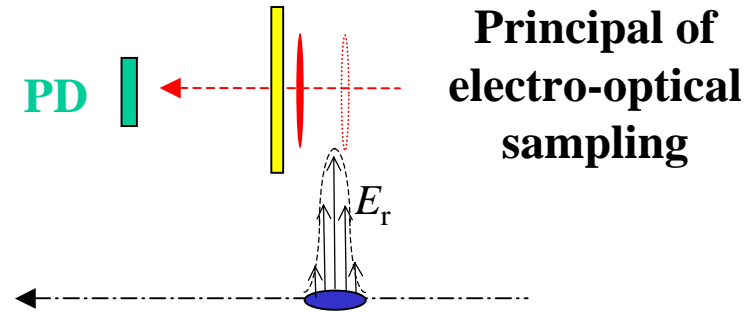

2. Chirp laser method:

- single shot method
- some more effort for laser and laser diagnostics required
- resolution due to laser $\sim \sqrt{t_0 \cdot t_{\text{chirp}}}$
- time window $\sim 1\text{-}20\text{ps}$

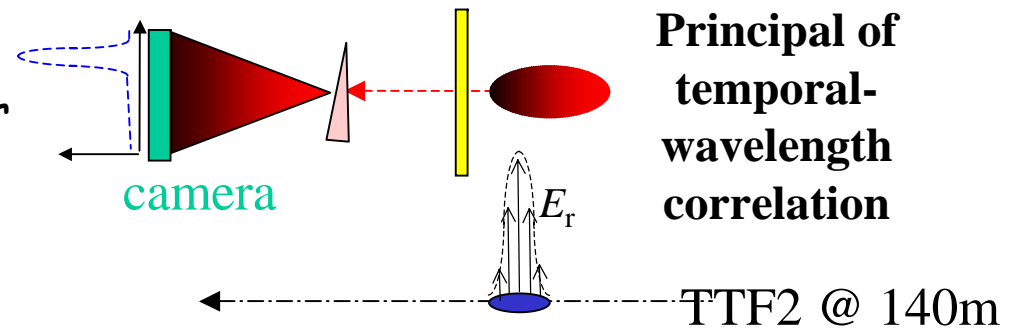

3. Spatial method:

- single shot method
- imaging optics is critical
- resolution due to geometry $> t_0 / \cos(\alpha)$
- time window $\sim 1\text{-}20\text{ps}$

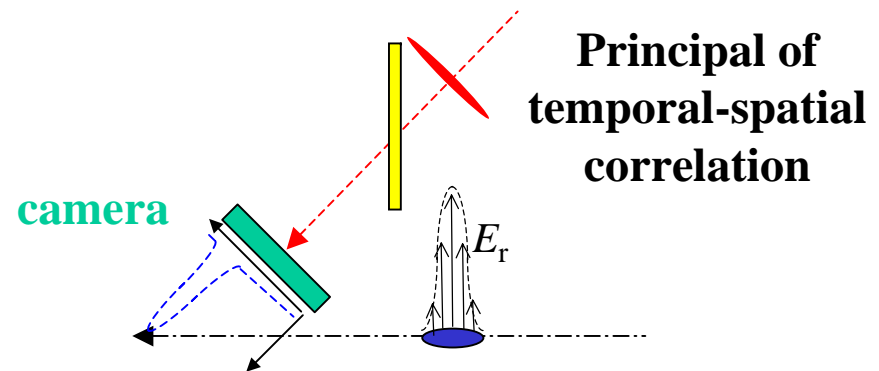

TTF2: Methods 1&2 installed at 140 m, method 3 will be used at 190 m

Electro-Optical Sampling

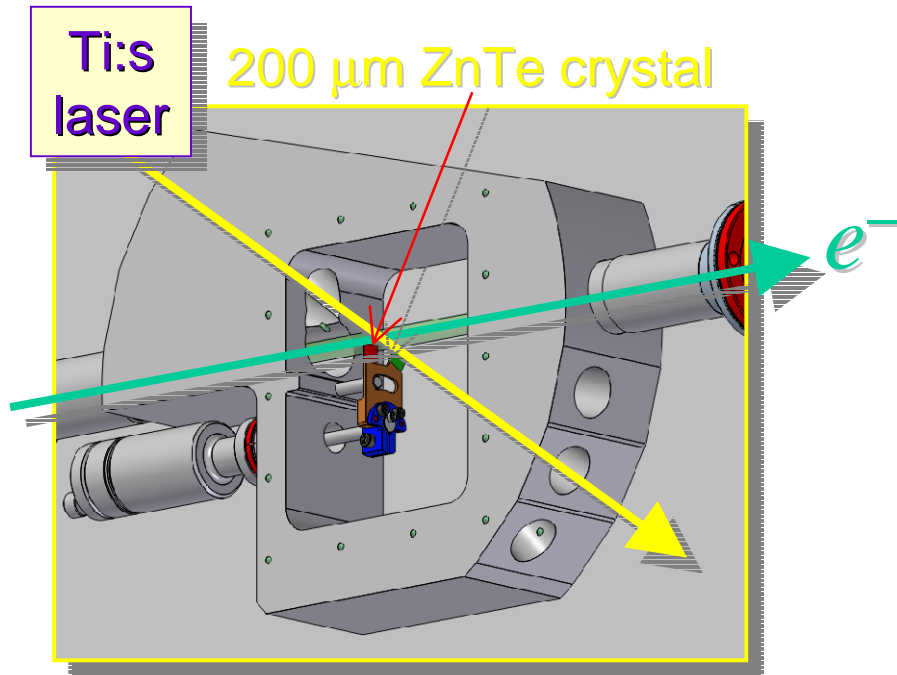

e^- temporal information is encoded on transverse profile of laser beam



Adrian Cavalieri et al., *U. Mich.*
Courtesy of J. Hastings

Single-Shot

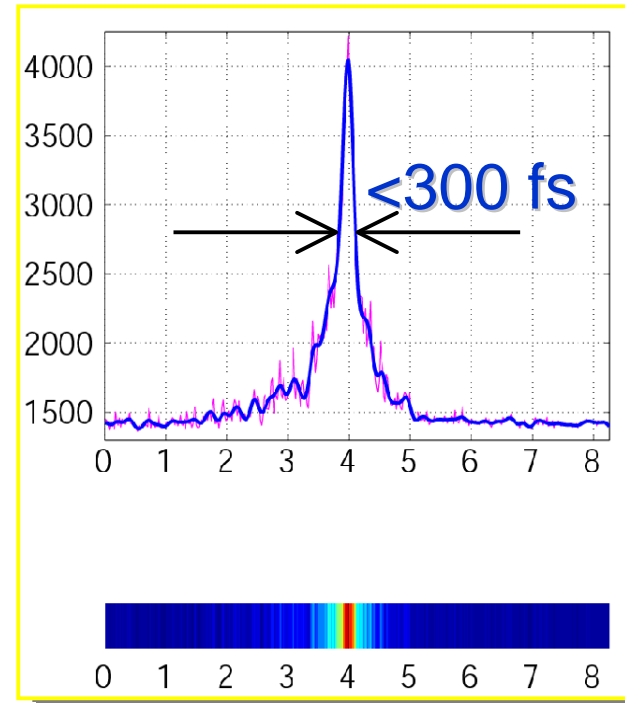

Timing Jitter (20 Shots)

